

COUPLING PROCEDURES INDEX

Selection/Preparation

Selection: 1000 - 1099

| | |
|--|---|
| 1000 Boss™ Clamp Selection | 5 |
| 1001 Pre-Formed Band Clamp Selection | 6 |
| 1002 Brass Reusable Fitting Selection | 7 |
| 1003 King Safety Cable™ Selection..... | 8 |

Preparation: 1100 - 1199

| | |
|---|-------|
| 1100 General Preparation Instructions | 9-10 |
| 1101 How To Use a Dixon® Diameter Tape | 11-12 |
| 1102 Clamp-It Band and Buckle Preparation | 13 |
| 1103 Set-up 5111A / 1765A Crimping Machine | 14 |

Installation

Boss™ Clamps: 2000 - 2099

| | |
|--|----|
| 2000 Boss™ 2 Bolt Clamps | 15 |
| 2001 Boss™ 4 Bolt Clamps | 16 |
| 2002 Boss™ 6 Bolt Clamps | 17 |
| 2003 750 and 850 Boss™ Clamps with 755 and 850A Piggyback Clamps | 18 |
| 2004 B49 Boss™ 6 Bolt Clamp using B49-2 Piggyback Clamp | 19 |

Band Clamps: 2100 - 2199

| | |
|--|----|
| 2100 Pre-Formed Band Clamp using Pneumatic Roll-Over Tool | 20 |
| 2101 Pre-Formed Band Clamp using Punch Style Tool | 21 |
| 2102 Pre-Formed Band Clamps using Punch Style Tool and Air King™ Hose Shank Couplings..... | 22 |
| 2103 Pre-Formed Band Clamps using Screw-Action Tool with Roll-Over Tool Attachment | 23 |
| 2104 Clamp-It Band and Buckle Installation using Screw-Action Tool | 24 |

Other Clamps: 2200 - 2299

| | |
|---|----|
| 2200 Strap-Grip Clamps | 25 |
| 2201 Double Bolt Clamps (with Saddles) | 26 |
| 2203 Pinch-On Clamps..... | 27 |

Installation (cont.)

Miscellaneous: 2300 - 2599

| | |
|--|----|
| 2300 King Safety Cable™ | 28 |
| 2301 Dixon® Menders | 29 |
| 2303 MIL H 29210C Steam Hose Assemblies | 30 |
| 2304 Brass Stems and Ferrules using 5111A and 1765A Tools..... | 31 |
| 2305 Brass Reusable Fittings | 32 |
| 2306 Crimping Uni-range, Air King™ (WF), Dix-Lock™ (WF), and Dual-Lock (WF) Couplings..... | 33 |
| 2307 Air King™ Crimp with Light Duty Ferrules | 34 |
| 2308 Connecting Vent-Lock™ Safety Cam and Groove Couplings | 35 |
| 2309 Connecting EZLink™ Armless Cam and Groove Couplings | 36 |
| 2400 King Crimp™ with Sleeves | 37 |
| 2401 King Crimp™ with Ferrules | 38 |
| 2402 Cam and Groove Coupling to Adapter | 39 |
| 2403 Assembling Cam and Groove Flanged Adapters..... | 40 |
| 2500 Crimp Boss™ Steam ¾" Continental Contitech Flexsteel® 250 Hose | 41 |
| 2501 Crimp Boss™ Steam 1" Texcel® Tex-Steam Hose | 42 |
| 2502 Crimp Boss™ Steam 1½" Continental Contitech Flexsteel® 250 Steam Hose | 43 |
| 2503 Crimp Boss™ Steam 1" Continental Contitech Flexsteel® 250 Hose | 44 |
| 2504 Crimp Boss™ Steam ¾" Gates 205MB Steam King® Hose | 45 |
| 2505 Crimp Boss™ Steam ¾" Texcel® Tex-Steam Hose | 46 |
| 2506 Crimp Boss™ Steam 1½" Gates 205MB Steam King® Hose | 47 |
| 2507: Steam Crimp – 1½" Texcel® Tex-Steam Hose..... | 48 |

COUPLING PROCEDURES INDEX

Inspection/Repair

Inspection: 3000 - 3099

3000 Criteria for Sufficient Fit of a Boss™ Clamp 49

3001 Bolt Clamp Inspection..... 50-51

3002 Band Clamp Inspection..... 52

3003 Inspecting Dixon® Cam and Groove 53-54

3004 Inspection and Maintenance of Food
Grade Internal Expansion Plugs 55

3005 General Assembly Inspection 56

3006 Inspection of Dixon® EZLink™ Armless
Cam and Groove Couplings 57

Repair: 3100 - 3199

3100 Cam Arm Replacement for Boss-Lock™
Cam and Groove Couplers 58

3101 EZLink™ Tab Replacement for 2", 3" and 4"
EZLink™ Cam and Groove Couplers 59

Testing

Hydrostatic: 4000 - 4099

4000 General Hydrostatic Testing Information..... 60

4001 Hydrostatic Test Procedure..... 61

4002 Test Pressures and Procedures for Boss-Lock™
and Dixon® Cam and Groove Couplings..... 62

Electrical: 4100 - 4199

4100 Electrical Continuity Testing 63

Safety Information

..... 64-67

Glossary

..... 68-73

Dixon® coupling procedures and videos
can be found at dixonvalve.com.



S.T.A.M.P.E.D.

When fabricating and specifying hose assemblies, ask the following questions:

- Size:** What is the ID (Inside Diameter) of the hose? What is the OD (Outside Diameter) of both ends of the hose? What is the overall length of the assembly required?
- Temperature:** What is the temperature range of the media (product) that is flowing through the hose assembly? What is the temperature range of the environment that surrounds the outside of the hose assembly?
- Application:** How is the hose assembly actually being used? Is it a pressure application? Is it a vacuum (suction) application? Is it a gravity flow application? Are there any special requirements that the hose assembly is expected to perform? Is the hose being used in a horizontal or vertical position? Are there any pulsations or vibrations acting on the hose assembly?
- Media:** What is the media/material that is flowing through the hose assembly? Being specific is critical. Check for: Abrasive materials, chemical compatibility, etc.
- Pressure:** What is the maximum pressure including surges (or maximum vacuum) that the hose assembly will be subjected to? Always rate the maximum working pressure of your hose assembly by the lowest rated component in the system.
- Ends:** What couplings have been requested by the user? Are they the proper fittings for the application and hose selected?
- Dixon®:** Dixon® recommends that, based on the hose, fittings and attachment method used, all assemblies be permanently marked with the designed working pressure and intended media. Do not use other manufacturers' fittings or ferrules with Dixon® products due to the differences in dimensions and tolerances. We also recommend that all hose assemblies be tested frequently.
Be Safe: Any questions on application, use or assembly, call 877-963-4966.

Procedure 1000: Boss™ Clamp Selection

effective 02/08

Preparation

- Refer to Procedure 1101: How to Use a Dixon® Diameter Tape (page 11).

Note

- Using the wrong size Boss™ clamp or installing a Boss™ clamp with a hose having an OD (Outside Diameter) that is outside its "From/To" range can result in damage to property and serious injury to personnel.



Process

- 1. Determine the hose ID (Inside Diameter).
- 2. Measure the hose "free" OD with a Dixon® diameter tape. "Free" OD is measured before the stem is inserted. Refer to Procedure 1101: How to Use a Dixon® Diameter Tape (page 11).
- 3. On the Boss™ Clamp page in the Boss™ Couplings section of the current DPL (Dixon® Product List) locate the "Hose ID" column.
- 4. Locate the section in that column that corresponds with the hose ID.
- 5. From that section, select the clamp with a hose OD range (Hose OD From/To columns) that best fits the hose OD just measured.
 - a. *For steam hose*, select the clamp that has a maximum range ("To" column) as close to the measured hose OD as possible. This will allow the clamp to be re-tightened many times to adjust for "cold-flow," which speeds up with increased temperature and/or hot/cold cycles.
 - b. *For hard wall constructed hose* (wire present) with an OD at or near the clamp's maximum range ("To" column), use of the next largest clamp may be required.
 - c. *For soft wall constructed hose* (no wire present) having an OD at or near the clamp's minimum range ("From" column), use of the next smallest clamp may be required. Select the proper clamp based on material requirements.
- 6. Select the proper clamp material based on the environmental compatibility requirements.

Tip: Make note of the Bolt Torque for the clamp selected, required for proper assembly.

Procedure 1001: Pre-Formed Band Clamp Selection

effective 02/08

Preparation

- 1. Refer to Procedure 1101: How to Use a Dixon® Diameter Tape (page 11).
- 2. Decide clamp style; Center Punch, Roll-Over or Universal.
- 3. Decide clamp width; $\frac{3}{8}$ ", $\frac{1}{2}$ ", $\frac{5}{8}$ " or $\frac{3}{4}$ ".
- 4. Decide clamp material; galvanized steel or stainless-steel.

Notes

- 1. If the clamp ID (Inside Diameter) is too large when using a pneumatic tensioning device (air tool), the clamp may not be tensioned properly.
- 2. If the clamp ID is too large when using a hand tensioning tool (punch tool or screw-action tool), the installation process takes longer than necessary.
- 3. If the clamp ID is too small, it may be difficult or impossible to properly position the clamps for tensioning after the coupling is inserted.
- 4. Always use the proper size clamp.

Process

- 1. Measure the hose "free" OD (Outside Diameter) with a Dixon® diameter tape. "Free" OD is measured before the stem is inserted. Refer to Procedure 1101: How to Use a Dixon® Diameter Tape (page 11).
- 2. From the Pre-Formed Band Clamp page of the current DPL (Dixon® Product List), select the clamp having an ID as close to the measured hose OD as possible, but not less than $\frac{1}{4}$ ".

Example: Hose OD: $2\frac{11}{16}$ "

Use: 3" ID clamp

Hose OD: $2\frac{7}{8}$ "

Use: $3\frac{1}{2}$ " ID clamp

Procedure 1002: Brass Reusable Fitting Selection

effective 02/08

Male and Female Fittings

- 1. Determine the hose ID (Inside Diameter).
- 2. Measure the hose "free" OD (Outside Diameter) with a Dixon® diameter tape. "Free" OD is measured before the stem is inserted. Refer to Procedure 1101: How to Use a Dixon® Diameter Tape (page 11).
- 3. Determine the thread size needed to connect the fitting.
- 4. Select the proper fitting from the Brass Reusable Fitting page of the current DPL (Dixon® Product List).

Example: Hose ID: $\frac{3}{8}$ "

Hose OD: $\frac{11}{16}$ "

Thread needed: $\frac{1}{4}$ " Male NPTF

Coupling: BN32RU68

Hose Splicers

- 1. Determine the hose ID.
- 2. Measure the hose "free" OD with a Dixon® diameter tape. "Free" OD is measured before the stem is inserted. Refer to Procedure 1101: How to Use a Dixon® Diameter Tape (page 11).
- 3. Select the proper fitting from the Brass Reusable Fitting page of the current DPL.

Example: Hose ID: $\frac{3}{8}$ "

Hose OD: $\frac{11}{16}$ "

Coupling: 187-0611

Procedure 1003: King Cable™ Selection

effective 02/08

Process

- 1. Determine style of cable to be used.
 - a. For applications where safety cable is to secure the hose to a stationary object such as a compressor, air tool or valve, use the Hose-to-Tool style.
 - b. For applications where the safety cable is to secure two hoses together, use the Hose-to-Hose style.
- 2. Determine the hose ID (Inside Diameter).
- 3. Determine assembly working pressure in PSI.
- 4. Select the proper cable from the King Cable™ page in the current DPL (Dixon® Product List).

Example: Secure hose to ball valve on compressor – Hose-to-Tool style.

Hose ID: 1½"

Working Pressure: **125 PSI**

Safety Cable required: WSR3

Note

- Under no circumstances should the assembly working pressure or working temperature exceed the working pressure or working temperature of the lowest rated component (coupling, clamp, ferrule or hose).

Procedure 1100: General Preparation Instructions

effective 02/08

Process

- 1. Cutting the Hose: The following two terms are used:
 - a. Cut to length means cut the hose to the length requested excluding the length of the fitting.
 - b. O.A.L. (Overall Length) refers to the overall length of the assembly including fittings.

Example: O.A.L. = requirement is 50 ft.

Fitting Length (each end) = 7"

Shank Length (each end) = 4"

| | | | | | | | | | | | | | | | | | |
|---|-------------------|-----|-----------------|-------|----------------------|-----|--------------------|-----|--------------------------|-----|---|----------------------------|------|----------------------|-------|-----------------|---------|
| <table style="width: 100%; border-collapse: collapse;"> <tr> <td style="width: 50%;">A. Fitting Length</td> <td style="width: 50%; text-align: right;">7 "</td> </tr> <tr> <td>B. Shank Length</td> <td style="text-align: right;">- 4 "</td> </tr> <tr> <td style="border-top: 1px solid black;">C. Subtract B from A</td> <td style="text-align: right; border-top: 1px solid black;">3 "</td> </tr> <tr> <td>D. Multiply C by 2</td> <td style="text-align: right;">x 2</td> </tr> <tr> <td style="border-top: 1px solid black;">E. Total Coupling Length</td> <td style="text-align: right; border-top: 1px solid black;">6 "</td> </tr> </table> | A. Fitting Length | 7 " | B. Shank Length | - 4 " | C. Subtract B from A | 3 " | D. Multiply C by 2 | x 2 | E. Total Coupling Length | 6 " | <table style="width: 100%; border-collapse: collapse;"> <tr> <td style="width: 50%;">F. Overall Length Required</td> <td style="width: 50%; text-align: right;">50 '</td> </tr> <tr> <td>G. Subtract E from F</td> <td style="text-align: right;">- 6 "</td> </tr> <tr> <td style="border-top: 1px solid black;">Cut Hose Length</td> <td style="text-align: right; border-top: 1px solid black;">49' 6 "</td> </tr> </table> | F. Overall Length Required | 50 ' | G. Subtract E from F | - 6 " | Cut Hose Length | 49' 6 " |
| A. Fitting Length | 7 " | | | | | | | | | | | | | | | | |
| B. Shank Length | - 4 " | | | | | | | | | | | | | | | | |
| C. Subtract B from A | 3 " | | | | | | | | | | | | | | | | |
| D. Multiply C by 2 | x 2 | | | | | | | | | | | | | | | | |
| E. Total Coupling Length | 6 " | | | | | | | | | | | | | | | | |
| F. Overall Length Required | 50 ' | | | | | | | | | | | | | | | | |
| G. Subtract E from F | - 6 " | | | | | | | | | | | | | | | | |
| Cut Hose Length | 49' 6 " | | | | | | | | | | | | | | | | |

- 2. Cut the Ends Square: Hose ends must be cut square (90° to the length of the hose) for proper coupling insertion. Improper insertion can reduce coupling retention.
Tip: Lubricate knife blade to ease cutting process.
- 3. Clean Hose Ends: Debris left inside the hose from the cutting process must be removed prior to coupling insertion. This is especially important when an abrasive wheel or 'chop saw' is used to make the cut. Debris will reduce coupling retention.
- 4. Determine Number of Clamps Required: Refer to the Pressure Chart in the DPL (Dixon® Product List) for correct number of clamps to install.
- 5. Mark Hose for Proper Clamp Placement: Bolt clamps without gripping fingers, all styles of band clamps (both pre-formed and bands and buckles) and Pinch-On clamps require proper placement to achieve maximum retention. Place marks as follows:
 - a. *For shanks having serrations that are all the same size (like King™ Combination Nipples):*
 1. Place shank next to hose to simulate shank being fully inserted.
 2. Place mark on hose corresponding with point of last serration (furthest from hose end).
 3. For multiple clamp installation, place additional mark(s) equally spaced between first mark and hose end ensuring that ¼" to ⅜" space is left between hose end and last clamp installed.
 - b. *For shanks having very pronounced serrations or irregularly sized serrations (like Cam and Groove):*
 1. Place shank next to hose to simulate shank being fully inserted.
 2. Place mark(s) on hose corresponding with the point(s) of the pronounced or large serration(s).

...continued on next page

Procedure 1100: General Preparation Instructions

(continued)

effective 6/16

- 6. Static Grounding: When static grounding is required, it is essential that it be done properly. Typically, it is accomplished by bending the built-in static wire or the helical wire(s) into the hose ID (Inside Diameter) so that the wire(s) makes contact with the metal coupling. Bend in no more wire than necessary. One half inch is usually sufficient. Other methods of static grounding may be required due to hose type, hose manufacturer or style of coupling being installed. Always contact the hose manufacturer to verify proper static grounding techniques for that particular hose. Improper static grounding can lead to fire, explosions, reduced assembly life, damage to property and injury or death to personnel.
Tip: For IX (Internal Expansion) couplings, bend the static wire to the outside. If it is put on the inside, the expansion process can fracture the wire reducing or eliminating electrical continuity.
- 7. For Hoses Having a Helical Wire: Determine in which direction the helical wire is pointing. Proper installation of pre-formed band clamps or bands and buckles relies upon the proper orientation of the clamp tail with the helical wire. See illustration below.

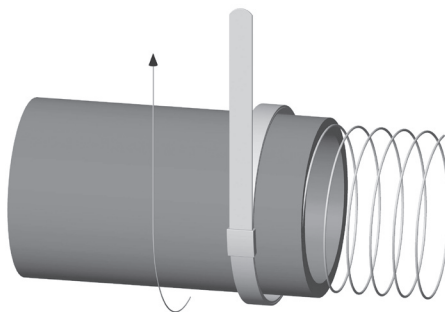

Note: If helical wire is not used for static grounding, trim the wire flush with the hose. This will prevent operator injuries during the assembly.



- 8. Seal the Hose Ends: At each end of the hose, the reinforcing material is exposed to outside elements. This exposure could lead to premature assembly failure if those outside elements are allowed to penetrate that reinforcing material. For this reason, the ends of the hose should be sealed. Typically, rubber cement or shellac is used. Contact the hose manufacturer for specific recommendations.
- 9. Apply Coupling Lubricant: Lubricate the coupling shank and hose inside diameter prior to coupling insertion. Dixon® recommends using Dixon® Coupling Lubricant (DCL10 pint, DCL80 gallon). Do not use hand soap, oil, grease, WD40, silicone spray or other substances that may attack the hose tube material and/or reduce coupling retention. 
Tip: Chamfer the hose ID, if necessary, to help guide the fitting into the hose.

Procedure 1101: How to Use a Dixon® Diameter Tape

effective 02/08

Preparation

- 1. One side of the Dixon® diameter tape is a standard measuring device. The other side is marked "INCHES OF DIA. BY 64THS" (see A in diagram one, on next page). This side of the tape measures OD (Outside Diameter).
- 2. Review markings on the diameter tape:
 - a. The unmarked line to the right of the "INCHES OF DIA. BY 64THS" label is the measurement line.
 - b. The number figures (1, 2, 3, etc.) with a line the width of the tape to the right of them indicate inches of diameter (see B in diagram one, on next page).
 - c. The number figures (16, 32 and 48) with a partial line below them are reference numbers. They identify $\frac{16}{64}$, $\frac{32}{64}$ and $\frac{48}{64}$ of an inch respectively (see D in diagram one, on next page).
 - d. The hash marks between the reference numbers represent $\frac{1}{64}$ of an inch, (see C in diagram one, on next page).

Notes

- 1. Many Dixon® clamping devices (example: Boss™ clamps, Holedall™ ferrules) are selected based on the OD of the hose on which they will be used. Each device has a minimum and maximum OD range. To ensure proper coupling performance, it is imperative that the clamping device selected be the correct size for the hose OD being used.
- 2. Always measure the OD on both ends of the hose.
 - a. Manufacturers may change dimensional specifications on their products without notification.
 - b. Allowable manufacturing tolerances in the hose may affect clamping device selection.
- 3. It is good practice to measure each hose end twice to ensure an accurate measurement.

Process

- 1. Grasping the diameter tape buckle, pull several inches of tape from the case.
- 2. With the diameter side of the tape facing up, loop the tape around the end of the hose keeping the loop 2-3" from the hose end.
- 3. Keep the buckle near the bottom of the loop.
- 4. Pull the tape tight to the hose.
- 5. The measurement line will line up with an inch of diameter mark, a reference number mark or a hash mark.
- 6. Read the hose OD:
 - a. If the measurement line lines up with a reference number or a hash mark to the LEFT of the 1" of diameter number, the OD of the hose is a fraction. The fraction uses the number of hash marks as the numerator and 64 as the denominator.
 - b. If the measurement line lines up with an inch of diameter number, the inches of diameter number is the OD of the hose (see diagram two, on next page).
 - c. If the measurement line lines up with a reference number to the RIGHT of the inches of diameter number, the hose OD is the inches of diameter number plus a fraction. The fraction uses the reference number as the numerator and 64 as the denominator (see diagram three, on next page).
 - d. If the measurement line lines up with a hash mark to the RIGHT of the inches of diameter number, the hose OD is the inches of diameter number plus a fraction. The fraction uses the number of hash marks to the RIGHT of the inches of diameter number as the numerator and 64 as the denominator (see diagram four, on next page).

...continued on next page

Procedure 1100: 1101: How to Use a Dixon® Diameter Tape

(continued)

effective 2/08

Diagram One

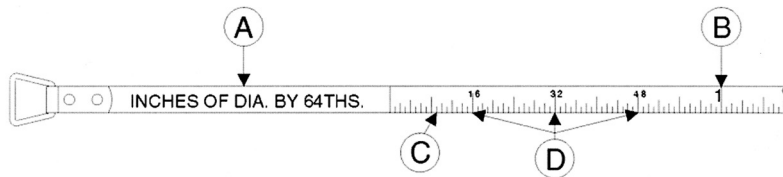

Diagram Two

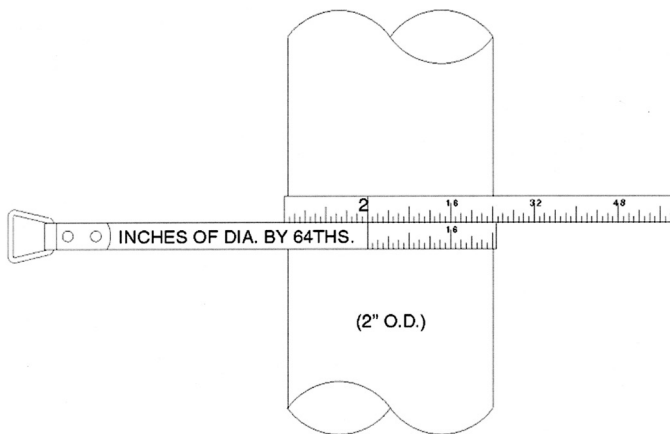

Diagram Three

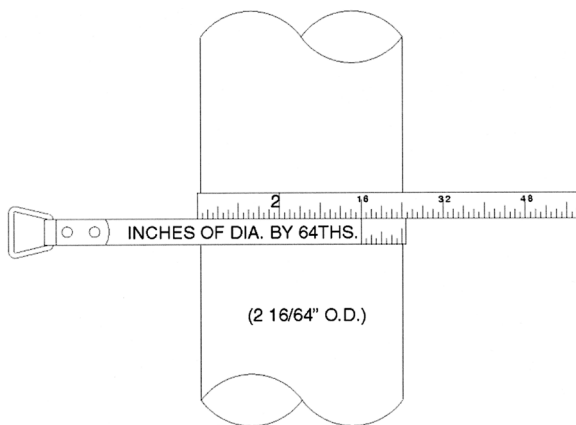
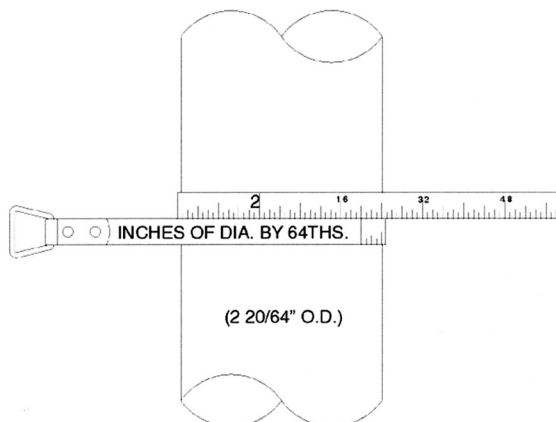

Diagram Four



Procedure 1102: Clamp-It Band and Buckle Preparation

effective 02/08

Notes

- 1. Strapping (band) edges can be extremely sharp! All necessary precautions should be taken to prevent installer's hands from being cut during the assembly process.
- 2. Do not use strapping and buckles made of different metals, or of different widths, together.



Example: 3/4" stainless-steel strapping must use 3/4" stainless-steel buckles.

Process

- 1. Measure the hose circumference with a standard tape measure.
- 2. Cut a piece of strapping that is 6" longer than two times the circumference.

| | |
|------------------------------------|-------|
| <i>Example:</i> Hose circumference | 13 " |
| Multiplied by 2 | x 2 |
| Equals | 26 " |
| Plus 6" | + 6 " |
| Total length of strap needed | 32 " |

- 3. Slide one end of the strap through the buckle loop. Make certain the 'ears' of the buckle are pointing up and are closest to the end of the strap.
- 4. Slide the buckle approximately 3" down the strap.
- 5. Using pliers, create a strap loop by bending approximately 1/2" of strap material down and under.
- 6. Slide the buckle into the strap loop.
- 7. Using pliers, crimp the strap loop tightly to the buckle. **Do not squeeze on the buckle loop.**
- 8. Wrap the free end of the strap around the hose and through the buckle loop.
- 9. Again, wrap the free end of the strap around the hose and through the buckle loop.
- 10. Using pliers, pull the free end of the strap as tight as possible.
- 11. Bend the strap free end up and slightly over the buckle. This will prevent the strap from sliding out from under the buckle.

Procedure 1103: Set-up 5111A/1765A Crimping Machines

effective 06/16

Preparation

- Using the appropriate table from the Brass Fitting section of the current DPL (Dixon® Product List), select the proper ferrule and die.

Notes

- 1. The ID (Inside Diameter) of the correct ferrule should be between 0.010" and 0.031" larger than the OD (Outside Diameter) of the hose.
- 2. Using ribbed dies or plain dies is a matter of preference.
- 3. When using ribbed dies with some ferrules, one 'rib' may crimp on the end of the ferrule resulting in an unacceptable appearance. If this happens, insert all die segments with numbers facing in.
- 4. **DO NOT** use the machine without the cover plate in place. 
- 5. If the wing nuts are too tight, the die holders may bind.

Process

For 5111A Machines

- 1. Remove the two wing nuts and the cover plate on the machine.
- 2. Insert the dies into the die holders with segment numbers facing out.
- 3. Replace cover plate and install wing nuts.

For 1765A Machines

- 1. Disconnect air supply.
- 2. Remove the two wing nuts and the cover plate on the machine.
- 3. Insert the dies into the die holders with numbers on all die segments facing out.
- 4. Replace cover plate and install wing nuts.
- 5. Loosen the thumbscrew on the stop and swing the stop down.
- 6. Ensure the machine is in the retracted (fully-open) position.
- 7. Slide the hose with stem and ferrule through the die opening.
- 8. For BFM and BFW style ferrules, align the end of the ferrule closest to the hose with the face of the dies.
- 9. For BF850, BFMW1050 and BFL style ferrules align the end of the ferrule closest to the hex on the stem with the face of the dies.
- 10. Swing the stop up and position it so that it contacts the end of the stem. Re-tighten the thumbscrew.
- 11. Reconnect air supply and crimp ferrule.
- 12. If necessary, adjust stop to position crimp in desired location on ferrule.

*Tip: After the dies have been inserted, and before the cover plate has been put on, cycle the machine so the dies are in the fully-closed position. If a gap is present between any die segments, the machine needs a full rebuild. **DO NOT** use the machine until this condition has been corrected.*

Procedure 2000: Installation of Boss™ 2 Bolt Clamp

effective 06/16

Tip: Use this procedure for Air King™ Clamp installation.



Selection

- 1. Select the proper Boss™ clamp using Procedure 1000: Boss™ Clamp Selection (page 5).
- 2. Inspect using Procedure 3000: Criteria for Sufficient Fit of a Boss™ Clamp (page 49).

Preparation

- Prepare the hose using Procedure 1100: General Preparation Instructions (pages 9-10).

Notes

- 1. Periodic bolt re-tightening is necessary due to "cold-flow" present in all rubber hoses.
- 2. Boss™ clamps (including nuts and bolts) are for a single use only! Once removed, discard. 
- 3. When installing stainless-steel bolts and nuts, the use of anti-seize or anti-galling lubricant is advised. A light coat is required on the bolt threads to prevent thread galling and artificial torque reading.
- 4. Torque values for brass and steel nuts and bolts are based upon "dry bolts." *Lubricant on bolts will adversely affect clamp performance.* 
- 5. After assembly of Boss™ clamps, Dixon® advises checking the torque setting daily for the first week, weekly for the first month and monthly thereafter.

Process

- 1. Insert shank into the hose. Refer to step 9 of Procedure 1100: General Preparation Instructions (pages 9-10).
- 2. Place the stem in a vise:
 - a. For male stems, tighten the vise on the hex.
 - b. For female stems (wing nut), place a spud in the vise, tighten and then thread the wing nut onto the spud.
- 3. Position the clamp gripping fingers behind the stem collar. See illustration below.
- 4. Tighten the bolts by hand until there is equal thread engagement. When hose OD (Outside Diameter) is at or near clamp maximum range, starting of nuts on bolts may require squeezing clamp halves in a vise.

Tip: Use the socket to aid hand tightening process.
- 5. Using a torque wrench, tighten bolts to the recommended torque value listed in the current DPL (Dixon® Product List). Tighten nuts on bolts in the following sequence. See illustration below.
 - a. Turn the front bolt one full turn.
 - b. Turn the opposite side bolt one full turn.
 - c. Repeat 'a' and 'b' until all bolts are tightened. Clamp bolts are designed to bend during tightening. This "bending" allows the clamp to conform to the hose circumference.
- 6. Inspect results using Procedure 3000: Criteria for Sufficient Fit of a Boss™ Clamp (page 49) and Procedure 3001: Bolt Clamp Inspection (pages 50-51).
- 7. Test the assembly using Procedure 4000: General Hydrostatic Testing Information (page 60) and Procedure 4001: Hydrostatic Testing (page 61).

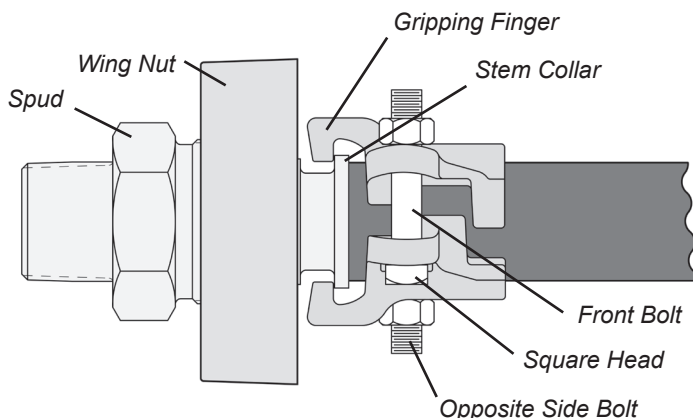

Procedure 2001: Installation of Boss™ 4 Bolt Clamp

effective 06/16



Selection

- 1. Select the proper Boss™ clamp using Procedure 1000: Boss™ Clamp Selection (page 5).
- 2. Refer to Procedure 3000: Criteria for Sufficient Fit of a Boss™ Clamp (page 49).

Preparation

- Prepare the hose using Procedure 1100: General Preparation Instructions (pages 9-10).

Notes

- 1. Periodic bolt re-tightening is necessary due to "cold-flow" present in all rubber hoses.
- 2. Boss™ clamps (including nuts and bolts) are for a single use only! Once removed, discard. 
- 3. When installing stainless-steel bolts and nuts, the use of anti-seize or anti-galling lubricant is advised. A light coat is required on the bolt threads to prevent thread galling and artificial torque reading.
- 4. Torque values for brass and steel nuts and bolts are based upon "dry bolts." *Caution: Lubricant on bolts will adversely affect clamp performance.* 
- 5. After assembly of Boss™ clamps, Dixon® advises checking the torque setting daily for the first week, weekly for the first month and monthly thereafter.

Process

- 1. Insert shank into the hose. Refer to step 9 of Procedure 1100: General Preparation Instructions (pages 9-10).
- 2. Place the stem in a vise:
 - a. For male stems, tighten the vise on the hex.
 - b. For female stems (wing nut), place a spud in the vise, tighten and then thread the wing nut onto the spud.
- 3. Position the clamp gripping fingers behind the stem collar. See illustration below.
- 4. Tighten the bolts by hand until there is equal thread engagement. When hose OD (Outside Diameter) is at or near clamp maximum range, starting of nuts on bolts may require squeezing clamp halves in a vise.

Tip: Use the socket to aid hand tightening process.

- 5. Using a torque wrench, tighten bolts to the recommended torque value listed in the current DPL (Dixon® Product List).

Tighten nuts on bolts in the following sequence. See illustration below.

 - a. Turn the back bolt one full turn.
 - b. Turn the front bolt one full turn.
 - c. Snug by hand the nuts on opposite side of bolts just tightened.
 - d. Turn the opposite back bolt one full turn.
 - e. Turn the opposite front bolt one full turn.
 - f. Snug by hand the nuts on opposite side of bolts just tightened.
 - g. Repeat 'a' to 'f' until all bolts are tightened. Clamp bolts are designed to bend during tightening.

This "bending" allows the clamp to conform to the hose circumference.

- 6. Inspect results using Procedure 3000: Criteria for Sufficient Fit of a Boss™ Clamp (page 49) and Procedure 3001: Bolt Clamp Inspection (pages 50-51).
- 7. Test the assembly using Procedure 4000: General Hydrostatic Testing Information (page 60) and Procedure 4001: Hydrostatic Testing (page 61).

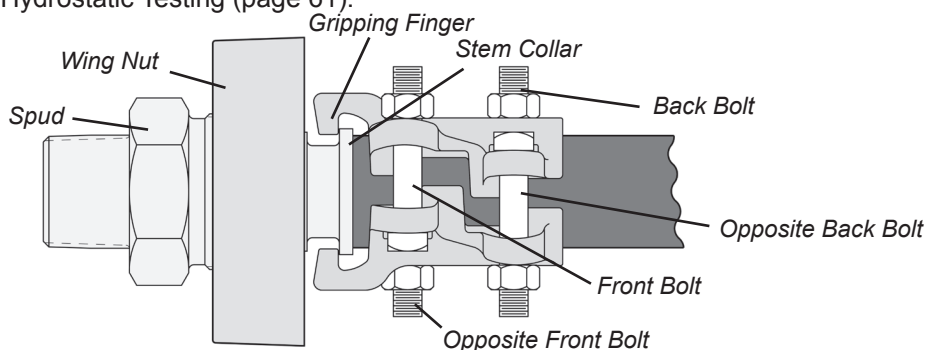

Procedure 2002: Installation of Boss™ 6 Bolt Clamp

effective 06/16



Selection

- 1. Select the proper Boss™ clamp using Procedure 1000: Boss™ Clamp Selection (page 5).
- 2. Refer to Procedure 3000: Criteria for Sufficient Fit of a Boss™ Clamp (page 49).

Preparation

- Prepare the hose using Procedure 1100: General Preparation Instructions (pages 9-10).

Notes

- 1. Periodic bolt re-tightening is necessary due to "cold-flow" present in all rubber hoses.
- 2. Boss™ clamps (including nuts and bolts) are for a single use only! Once removed, discard. 
- 3. When installing stainless-steel bolts and nuts, the use of anti-seize or anti-galling lubricant is advised. A light coat is required on the bolt threads to prevent thread galling and artificial torque reading.
- 4. Torque values for brass and steel nuts and bolts are based upon "dry bolts." *Caution: Lubricant on bolts will adversely affect clamp performance.* 
- 5. After assembly of Boss™ clamps, Dixon® advises checking the torque setting daily for the first week, weekly for the first month and monthly thereafter.

Process

- 1. Insert shank into the hose. Refer to step 9 of Procedure 1100: General Preparation Instructions (pages 9-10).
- 2. Place the stem in a vise:
 - a. For male stems, tighten the vise on the hex.
 - b. For female stems (wing nut), place a spud in the vise, tighten and then thread the wing nut onto the spud.
- 3. Position the clamp gripping fingers behind the stem collar.
- 4. Tighten the bolts by hand until there is equal thread engagement on all six nuts and they are snug.

Tip: Use the socket to aid hand tightening process.
- 5. Using a torque wrench, tighten bolts to the recommended torque value listed in the current DPL (Dixon® Product List). Tighten nuts on bolts in the following sequence. See illustration below.
 - a. Turn bolt #1 one full turn.
 - b. Turn bolt #2 one full turn.
 - c. Turn bolt #3 one full turn.
 - d. Turn bolt #4 one full turn.
 - e. Turn bolt #5 one full turn.
 - f. Turn bolt #6 one full turn.
 - g. Repeat 'a' to 'f' until all bolts are tightened. Clamp bolts are designed to bend during tightening. This "bending" allows the clamp to conform to the hose circumference.
- 6. Inspect results using Procedure 3000: Criteria for Sufficient Fit of a Boss™ Clamp (page 49) and Procedure 3001: Bolt Clamp Inspection (pages 50-51).
- 7. Test the assembly using Procedure 4000: General Hydrostatic Testing Information (page 60) and Procedure 4001: Hydrostatic Testing (page 61).

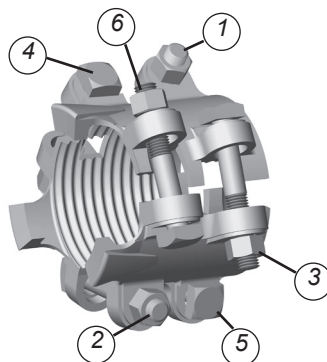

Procedure 2003: Installation of Boss™ 755 and 850 Piggyback Clamps

effective 08/15



Selection

- 1. Use 755 piggyback clamp for 750 Boss™ clamp. Use 850A piggyback clamp for 850 Boss™ clamp.
- 2. Refer to Procedure 3000: Criteria for Sufficient Fit of a Boss™ Clamp (page 49).

Preparation

- Install the 750 or 850 clamp using Procedure 2002: Installation of Boss™ 6 Bolt Clamp (page 17).

Notes

- 1. Periodic bolt re-tightening is necessary due to "cold-flow" present in all rubber hoses.
- 2. Boss™ clamps (including nuts and bolts) are for a single use only! Once removed, discard. 
- 3. When installing stainless-steel bolts and nuts, the use of anti-seize or anti-galling lubricant is advised. A light coat is required on the bolt threads to prevent thread galling and artificial torque reading.
- 4. Torque values for brass and steel nuts and bolts are based upon "dry bolts." *Caution: Lubricant on bolts will  adversely affect clamp performance.*
- 5. After assembly of Boss™ clamps, Dixon® advises checking the torque setting daily for the first week, weekly for the first month and monthly thereafter.

Process

- 1. Position the holes in each segment of the piggyback clamp over the pigtails of the 750 or 850 clamp just installed.
- 2. Tighten the bolts by hand until there is equal thread engagement on all six nuts and they are snug.
Tip: Use the socket to aid hand tightening process.
- 3. Using a torque wrench, tighten bolts to the recommended torque value listed in the current DPL (Dixon® Product List). *Note: Torque values for steel nuts and bolts are based upon "dry bolts." Lubricant on bolts will adversely affect clamp performance.* 

Tighten nuts on bolts in the following sequence. See illustration below.

- a. Turn bolt #1 one full turn.
 - b. Turn bolt #2 one full turn.
 - c. Turn bolt #3 one full turn.
 - d. Turn bolt #4 one full turn.
 - e. Turn bolt #5 one full turn.
 - f. Turn bolt #6 one full turn.
 - g. Repeat 'a' to 'f' until all bolts are tightened to recommended torque.
- 4. Re-tighten bolts on 750 or 850 clamp, as per 'a' through 'g' above.
 - 5. Re-tighten bolts on 755 or 850A piggyback clamp, as per 'a' through 'g' above.
 - 6. Repeat until all 12 bolts are tightened to recommended torque. Clamp bolts are designed to bend during tightening. This 'bending' allows the clamp to conform to the hose circumference.
 - 7. Inspect results using Procedure 3000: Criteria for Sufficient Fit of a Boss™ Clamp (page 49) and Procedure 3001: Bolt Clamp Inspection (pages 50-51).
 - 8. Test the assembly using Procedure 4000: General Hydrostatic Testing Information (page 60) and Procedure 4001: Hydrostatic Testing (page 61).

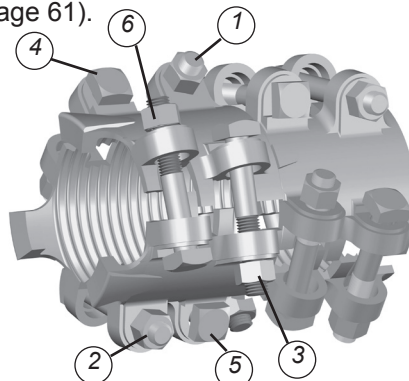

Procedure 2004: Installation of Boss™ B49-2 Piggyback Clamps

effective 06/16



Selection

- 1. Install the B49 clamp using Procedure 2002: Installation of Boss™ 6 Bolt Clamp (page 17).
- 2. Refer to Procedure 3000: Criteria for Sufficient Fit of a Boss™ Clamp (page 49).

Preparation

- Install the B49 clamp using Procedure 2002: Installation of Boss™ 6 Bolt Clamp (page 17).

Notes

- 1. Periodic bolt re-tightening is necessary due to "cold-flow" present in all rubber hoses.
- 2. Boss™ clamps (including nuts and bolts) are for a single use only! Once removed, discard. 
- 3. When installing stainless-steel bolts and nuts, the use of anti-seize or anti-galling lubricant is advised. A light coat is required on the bolt threads to prevent thread galling and artificial torque reading.
- 4. Torque values for brass and steel nuts and bolts are based upon "dry bolts." *Caution: Lubricant on bolts will adversely affect clamp performance.* 
- 5. After assembly of Boss™ clamps, Dixon® advises checking the torque setting daily for the first week, weekly for the first month and monthly thereafter.

Process

- 1. Position the holes in each segment of the piggyback clamp over the pigtails of the B49 clamp just installed.
- 2. Tighten the bolts by hand until there is equal thread engagement on all six nuts and they are snug.
Tip: Use the socket to aid hand tightening process.
- 3. Using a torque wrench, tighten bolts to the recommended torque value listed in the current DPL (Dixon® Product List). *Note: Torque values for steel nuts and bolts are based upon "dry bolts." Lubricant on bolts will adversely affect clamp performance.* 
Tighten nuts on bolts in the following sequence. See illustration below.
 - a. Turn bolt #1 one full turn.
 - b. Turn bolt #2 one full turn.
 - c. Turn bolt #3 one full turn.
 - d. Turn bolt #4 one full turn.
 - e. Turn bolt #5 one full turn.
 - f. Turn bolt #6 one full turn.
- g. Repeat 'a' to 'f' until all bolts are tightened to recommended torque.
- 4. Re-tighten bolts on B49 clamp, as per 'a' through 'g' above.
- 5. Re-tighten bolts on B49-2 piggyback clamp, as per 'a' through 'g' above.
- 6. Repeat until all 12 bolts are tightened to recommended torque. Clamp bolts are designed to bend during tightening. This 'bending' allows the clamp to conform to the hose circumference.
- 7. Inspect results using Procedure 3000: Criteria for Sufficient Fit of a Boss™ Clamp (page 49) and Procedure 3001: Bolt Clamp Inspection (pages 50-51).
- 8. Test the assembly using Procedure 4000: General Hydrostatic Testing Information (page 60) and Procedure 4001: Hydrostatic Testing (page 61).

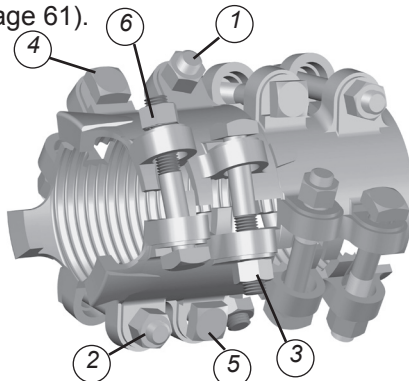

Procedure 2100: Installation of Pre-Formed Band Clamps Using Pneumatic Roll-Over Tool

effective 06/16

Selection

- Select the proper pre-formed band clamp using Procedure 1001: Pre-formed Band Clamp Selection (page 6).

Preparation

- Prepare and mark the hose using Procedure 1100: General Preparation Instructions (pages 9-10).

Notes

- 1. For hoses having a helical wire, make certain that the clamp tail and the helical wire are pointing in the same direction. Refer to Procedure 1100: General Preparation Instructions (page 10) for illustration.
- 2. Always follow the tool manufacturer's recommendations for 'pull-up' and holding pressure settings on the air tool regulator. These settings are based on band width and band material. Proper settings are essential for satisfactory clamp performance.
- 3. When multiple clamps are used, clamp buckles must be offset to prevent a leak path; 2 clamps - buckles at 180°, 3 clamps - buckles at 120° and 4 clamps - buckles at 90°.

Process

- 1. Slide the clamp(s) over the hose end.
- 2. Insert the coupling. Refer to step 9 of Procedure 1100: General Preparation Instructions (pages 9-10).
- 3. Adjust the air tool regulator to its proper setting.
- 4. Use the air tool as follows:
 - a. Activate tool-tensioning stroke. Tool will tension clamp until 'pull-up' pressure is achieved.
 - b. Relieve pressure on tool until holding pressure is achieved.
 - c. Roll up the hose until the clamp buckle engages the cutting tool.
 - d. Quickly pull on the cutting tool handle to snap the clamp tail.
 - e. Reverse the air tool and remove the clamp tail.
 - f. For assemblies using multiple clamps, repeat the process.
- 5. Inspect results using Procedure 3002: Band Clamp Inspection (page 52).
- 6. Test the assembly using Procedure 4000: General Hydrostatic Testing Information (page 60) and Procedure 4001: Hydrostatic Testing (page 61).

Procedure 2101: Installation of Pre-Formed Band Clamps Using Punch Style Tool

effective 06/16

Selection

- Select the proper pre-formed band clamp using Procedure 1001: Pre-formed Band Clamp Selection (page 6).



Preparation

- Prepare and mark the hose using Procedure 1100: General Preparation Instructions (pages 9-10).

Notes

- 1. For hoses having a helical wire, make certain that the clamp tail and the helical wire are pointing in the same direction. Refer to Procedure 1100: General Preparation Instructions (page 10) for illustration.
- 2. Never grasp the knob of a punch style tool with a 'closed fist.' If the clamp tail breaks suddenly, there will be no resistance to the operator's pressure on the lever and injury to the operator may occur.
- 3. Testing is the only way to know for sure if proper tension has been achieved. As a visual indicator, the clamp OD (Outside Diameter) should be equal to or less than the hose OD.
- 4. In some instances, it may be impossible to lower the knobbed lever to the full down position without the risk of prematurely breaking the clamp's tail or damaging the tool. When this situation arises, move the pulling dog lever on the tool to release the knobbed lever, then lower the knobbed lever to the full down position.
- 5. Use a hammer or mallet with a malleable iron or brass head. Using one with a case hardened head, such as a claw hammer or ball-peen hammer, will dramatically shorten the tool's life, and if it shatters, could cause severe injury to the operator.

Process

- 1. Slide the clamp(s) over the hose end.
- 2. Insert the coupling. Refer to step 9 of Procedure 1100: General Preparation Instructions (pages 9-10).
- 3. To use the punch style tool:
 - a. Insert clamp tail into the slot until the clamp buckle is against the tool head.
 - b. Place the 'T' handle on a flat surface.
 - c. Using an opened palm on the knob, raise and lower the lever fully. 
 - d. Repeat Step 'c' until clamp is properly tensioned.
 - e. When clamp is properly tensioned, have the knobbed lever in the full down position.
 - f. Strike the tool punch with a soft-headed hammer or mallet several times to set the lock.
 - g. Firmly hold the hose with one hand. Raise then lower the tool to break the clamp's tail. 
 - h. For assemblies using multiple clamps, repeat the process.
Note: When multiple clamps are used, clamp buckles must be offset to prevent a leak path; 2 clamps - buckles at 180°, 3 clamps - buckles at 120° and 4 clamps - buckles at 90°.
- 4. Inspect results using Procedure 3002: Band Clamp Inspection (page 52).
- 5. Test the assembly using Procedure 4000: General Hydrostatic Testing Information (page 60) and Procedure 4001: Hydrostatic Testing (page 61).

Procedure 2102: Installation of Pre-Formed Band Clamps Using Punch Style Tool and Air King™ Hose Shank Couplings

effective 06/16

Selection

- Select the proper pre-formed band clamp using Procedure 1001: Pre-formed Band Clamp Selection (page 6).

Preparation

- 1. Prepare and mark the hose using Procedure 1100: General Preparation Instructions (pages 9-10).
- 2. Refer to Procedure 2101: Installation of Pre-formed Band Clamps Using Punch Style Tool (page 21).

Notes

- 1. For hoses having a helical wire, make certain that the clamp tail and the helical wire are pointing in the same direction. Refer to Procedure 1100: General Preparation Instructions (page 10) for illustration.
- 2. Never grasp the knob of a punch style tool with a closed fist. 
- 3. Testing is the only way to know for sure that proper tension has been achieved.
- 4. When the knobbed lever will not go to the full down position, move the pulling-dog lever to release the knobbed lever.
- 5. Use a hammer or mallet with a malleable iron or brass head.
- 6. When multiple clamps are used, clamp buckles must be offset to prevent a leak path.

Process

- 1. Slide the clamp(s) over the hose end.
- 2. Insert the coupling. Refer to step 9 of Procedure 1100: General Preparation Instructions (pages 9-10).
 - a. *For single clamp installations on 3/8" and 1/2" couplings:*
 - 1) Position the clamp midway between the mark on the hose and the hose end.
 - 2) Tension the clamp.
 - b. *For double clamp installations on 3/4" and 1" couplings:*
 - 1) Position the first clamp just inside (hose end side) the mark on the hose.
 - 2) Tension the clamp.
 - 3) Position the second clamp midway between the clamp just installed and the hose end.
 - 4) Tension the clamp.
 - c. *For double clamp installation on 5/8" coupling:*
 - 1) Position the first clamp just inside the (hose end side) mark furthest away from the hose end.
 - 2) Tension the clamp.
 - 3) Position the second clamp just inside the (hose end side) mark closest to the hose end.
 - 4) Tension the clamp.
- 3. Inspect results using Procedure 3002: Band Clamp Inspection (page 52).
- 4. Test the assembly using Procedure 4000: General Hydrostatic Testing Information (page 60) and Procedure 4001: Hydrostatic Testing (page 61).

Procedure 2103: Installation of Pre-Formed Band Clamps Using Screw-Action Tool with Roll-Over Tool Attachment

effective 06/16

Selection

- Select the proper pre-formed band clamp using Procedure 1001: Pre-formed Band Clamp Selection (page 6).

Preparation

- Prepare and mark the hose using Procedure 1100: General Preparation Instructions (pages 9-10).

Notes

- 1. For hoses having a helical wire, make certain that the clamp tail and the helical wire are pointing in the same direction. Refer to Procedure 1100: General Preparation Instructions (page 10) for illustration.
- 2. Testing is the only way to know for sure if the proper tension has been achieved. However, as a visual indicator, the clamp OD (Outside Diameter) will be equal to or less than the hose OD.
- 3. If the tool runs out of stroke before the clamp is tight; rotate handles counter-clockwise, slide the pulling dog head until it contacts screw-action tool head, push down on the pulling-dog lever and rotate the handles clockwise until the clamp is properly tensioned.
- 4. When multiple clamps are used, clamp buckles must be offset to prevent a leak path; 2 clamps - buckles at 180°, 3 clamps - buckles at 120° and 4 clamps - buckles at 90°.

Process

- 1. Slide the clamp(s) over the hose end.
- 2. Insert the coupling. Refer to step 9 of Procedure 1100: General Preparation Instructions (pages 9-10).
- 3. Secure the screw-action tool in a vise. Position it so that the tightening handles are on the right.
- 4. Install the roll-over attachment onto the screw-action tool head. Make sure that the cutting lever is facing the operator.
- 5. Use the screw-action tool as follows:
 - a. Rotate the tightening handles counter-clockwise until the pulling dog head contacts the tool head.
 - b. Insert the clamp tail through the slot on Roll-Over tool until the clamp buckle contacts the tool head.
 - c. Pre-tension the clamp by pushing down on pulling dog lever.
 - d. Rotate tightening handles clockwise. Continue rotating handles until the pulling dog lever can be released without band slippage.
 - e. Insert the hose through the clamp and into its proper position.
 - f. Rotate tightening handles clockwise until the clamp has been properly tensioned.
 - g. **Caution!** Bend excessive clamp tail away from tool handles to avoid being cut by sharp edges. 
 - h. Rotate handles counter-clockwise (no more than one full turn) while rolling the hose towards the operator. Continue rotating the hose until the clamp buckle engages the cutting bar of the attachment tool.
 - i. Quickly pull the cutting lever towards the operator.
 - j. Remove the clamp tail from the pulling dog.
 - k. For assemblies using multiple clamps, repeat the process.
- 6. Inspect results using Procedure 3002: Band Clamp Inspection (page 52).
- 7. Test the assembly using Procedure 4000: General Hydrostatic Testing Information (page 60) and Procedure 4001: Hydrostatic Testing (page 61).

Tip: Always wear leather gloves to avoid cuts from sharp edges.

Procedure 2104: Installation of Clamp-It Band and Buckle Using Screw-Action Tool

effective 02/08

Preparation

- 1. Prepare and mark the hose using Procedure 1100: General Preparation Instructions (pages 9-10).
- 2. Cut the proper length of strapping and form it to make the clamp(s) using Procedure 1102: Clamp-It Band and Buckle Preparation (page 13).

Process

- 1. Slide the clamp(s) over the hose end. For hoses having a helical wire, make certain that the clamp tail and the helical wire are pointing in the same direction. Refer to Procedure 1100: General Preparation Instructions (page 10) for illustration.
- 2. Insert the coupling. Refer to step 9 of Procedure 1100: General Preparation Instructions (pages 9-10).
- 3. Use Screw-Action Tool as follows:
 - a. Rotate the tightening handles counter-clockwise until the pulling dog head contacts the tool head.
 - b. Place the tool in left hand with cutter lever on the bottom and pulling dog lever on the top.
Hold cutter lever and pulling dog lever so that they do not cover the slot on the side of the tool.
 - c. Slide the clamp tail of the strap into the slot.
 - d. Slide the tool down the strap until the tool head contacts the buckle.
 - e. Press down on the pulling dog lever, then rotate the tightening handles clockwise.
Continue rotating handles until the pulling dog lever can be released without the band slipping.
 - f. Rotate the tightening handles clockwise until the clamp has been properly tensioned.
Note: Testing is the only way to know for sure if the proper tension has been achieved.
However, as a visual indicator, the clamp OD should be equal to or less than the hose OD
 - g. *Note:* If the tool runs out of stroke before the clamp is tight, rotate handles counter-clockwise, slide the pulling-dog head until it contacts the screw-action tool head and push down on the pulling-dog lever.
and rotate the handles clockwise until clamp is properly tensioned.
Caution! Bend excessive clamp tail away from the tool handles to avoid being cut by sharp edges. 
 - h. Rotate handles counter-clockwise (no more than one full turn) while lifting the tool as far as possible.
 - i. Quickly pull the cutting lever towards the operator.
 - j. Bend the remaining strap tail between the ears on the buckle.
 - k. Using a hammer, tap the buckle ears down on the strap.
 - l. Remove the clamp tail from the pulling dog.
 - m. For assemblies using multiple clamps, repeat the process.
Note: When multiple clamps are used, clamp buckles must be offset to prevent a leak path; 2 clamps - buckles at 180°, 3 clamps - buckles at 120° and 4 clamps - buckles at 90°.
- 4. Inspect results using Procedure 3002: Band Clamp Inspection (page 52).
- 5. Test the assembly using Procedure 4000: General Hydrostatic Testing Information (page 60) and Procedure 4001: Hydrostatic Testing (page 61).
Tip: Always wear leather gloves to avoid cuts from sharp edges.

Procedure 2200: Installation of Strap-Grip Clamps

effective 02/08

Selection

- Use Procedure 1001: Pre-formed Band Clamp Selection (page 6).

Preparation

- 1. Prepare the hose using Procedure 1100: General Preparation Instructions (pages 9-10).
- 2. If the hose has a 3" or larger ID (Inside Diameter), it must be sealed with a band clamp prior to installing the two saddles of the Strap-Grip Clamp. The process for installing the sealing band is as follows:
 - a. Position one saddle so that the gripping finger is behind the stem collar.
 - b. Place marks on hose to correspond to the inside edges of both cross members.
 - c. Remove the clamp.
 - d. Install and properly tension a pre-formed band clamp between the marks using one of the following procedures:
 - Procedure 2100: Installation on Pre-Formed Band Clamps Using Pneumatic Roll-over Tool (page 20)
 - Procedure 2101: Installation of Pre-formed Band Clamps Using Punch Style Tool (page 21)
 - Procedure 2103: Installation of Pre-Formed Band Clamps Using Screw-Action Tool with Roll-Over Tool Attachment (page 23)

Process

- 1. Set one saddle on the hose, positioning the gripping finger behind the stem collar.
Note: The interlock between the clamp gripping finger and the stem collar must be a minimum of $1/32$ " unless the hose has a 3" or larger ID in which case, it must be $1/16$ ".
- 2. Secure it with tape (duct, electrical, etc.). Tape should be placed between the cross members.
- 3. Place the other saddle on the opposite side of the hose and secure it with tape.
- 4. Using the appropriate procedure, 'snug' the first band clamp over the cross members furthest away from the hose end. The buckles of the band clamps securing the saddles should be between the saddles but on opposite sides.
Note: If the hose has a 3" or larger ID, the buckles should still be between the saddles, however they should be on the side opposite the sealing band buckle.
- 5. Remove the tool from the strap tail.
- 6. Snug the second band clamp over the cross members closest to the hose end.
- 7. Remove the tool from the strap tail.
- 8. Properly tension the first band clamp.
- 9. Properly tension the second band clamp.
- 10. Inspect results using Procedure 3002: Band Clamp Inspection (page 52).
- 11. Test assembly using Procedure 4000: General Hydrostatic Testing Information (page 60) and Procedure 4001: Hydrostatic Testing (page 61).

Procedure 2201: Installation of Double Bolt Clamps (with Saddles)

effective 06/16

Selection

- 1. Select the correct double bolt clamp from the Clamp section of the current DPL (Dixon® Product List).
- 2. **Consult Dixon® for guidance using double bolt clamps on hose with a helical wire.**

Preparation

- Prepare the hose using Procedure 1100: General Preparation Instructions (pages 9-10).

Notes

- 1. Periodic bolt re-tightening is necessary due to "cold-flow" that is present in all rubber hoses.
- 2. Double bolt clamps (including their nuts and bolts) are for a single use only! Once removed, discard. 

Process

- 1. Slide the clamp(s) over the hose end.
- 2. Insert the coupling. Refer to step 9 of Procedure 1100: General Preparation Instructions (pages 9-10).
- 3. Place the clamp(s) into the proper position.
 - a. Lettering detail (ex: "Dixon® V&C") should face the same direction for all clamps.
 - b. When using multiple clamps, offset the saddles to prevent line leak; 2 clamps - saddle centers at 90°, 3 clamps - saddle centers at 60° and 4 clamps - saddle centers at 90°.
 - c. The clamp must be perpendicular to the hose body. Uneven bolt tightening may result in a clamp that is angled and has sealing and retention problems.
- 4. Install the clamp as follows:
 - a. Position the saddles so they are fully under the clamp halves.
 - b. Hand-tighten both nuts equally.
Tip: Use socket to aid hand tightening process
 - c. Using a permanent marker, place a mark near the nut on one of the bolt lugs.
 - d. Tighten that nut one full turn.
 - e. Tighten the opposite side nut one full turn.
 - f. Continue tightening nuts one turn at a time, alternating back and forth until the saddles no longer move freely.
 - g. Using a hammer and punch, reposition the saddles so they are fully under the clamp halves.
Position the saddle loop (where the bolt goes through) slightly off center towards the bolt head.
- 5. Continue tightening nuts, alternating back and forth until both are tightened to the recommended torque value listed on the Double Bolt Clamp page of the current DPL.
Note: Torque values are based upon "dry bolts." Lubricating bolts will adversely affect clamp performance. 
Use a torque wrench. The bolts will bend during tightening. This allows the clamp to work properly.
- 6. An excessive amount of bolt past the nut may be removed by using bolt cutters or a hack saw.
Tip: Never cut off excess bolt with blow torch. Doing so can weaken the bolt to the point of failure while in service
- 7. For assemblies using multiple clamps, repeat steps 2 through 5.
- 8. Inspect results using Procedure 3001: Bolt Clamp Inspection (pages 50-51).
- 9. Test assembly using Procedure 4000: General Hydrostatic Testing Information (page 60) and Procedure 4001: Hydrostatic Testing (page 61).

Procedure 2203: Installation of Pinch-On Clamps

effective 02/08

Selection

- 1. Measure the hose OD (Outside Diameter).
- 2. Select the clamp that has a nominal size closest to the hose OD.
- 3. See current DPL (Dixon® Product List) for nominal size selection.
- 4. The clamp selected must be able to slide over the hose OD after stem insertion.

Preparation

- 1. Prepare the hose using Procedure 1100: General Preparation Instructions (pages 9-10).
- 2. Determine the proper number of pinch-on clamps required:
 - a. For pronounced shanks use the same number of clamps as there are marks on the hose.
 - b. For symmetrical shanks $\frac{3}{8}$ " and below; 1 clamp.
 - c. For symmetrical shanks $\frac{1}{2}$ " to 1"; 2 clamps.

Process

- 1. Slide the correct number of clamps over the hose end.
- 2. Insert the coupling. Refer to step 9 of Procedure 1100: General Preparation Instructions (pages 9-10).
- 3. *For single ear clamps:*
 - a. Position the clamp(s) over the shank.
 - b. Pinch the clamp ear as tight as possible without shearing the clamp.
 - c. Check the clamp ear. If both sides of the clamp-ear touch, then the clamp is too large. Remove the clamp and install the next smaller clamp.
 - d. For multiple clamp installations, repeat the process.
Note: Make sure the clamp ears are not lined up.
- 4. *For double ear clamps:*
 - a. Position the clamp(s) over the shank.
 - b. Pinch one clamp ear as tight as possible (both sides of clamp ear touch).
 - c. Pinch the other clamp ear as tight as possible without shearing the clamp.
 - d. Check clamp ears as follows:
 - 1. The first ear that was pinched may open slightly. This is acceptable.
 - 2. If both ears close completely, the clamp is too large. Remove clamp and install the next smaller clamp.
 - e. For multiple clamp installations, repeat the process.
Note: Make sure the clamp ears are not lined up.
- 5. Test assembly using Procedure 4000: General Hydrostatic Testing Information (page 60) and Procedure 4001: Hydrostatic Testing (page 61).

Procedure 2300: Installation of King Safety Cable™

effective 02/08

Selection

- Cable selection is based on the hose ID (Inside Diameter) and the assembly working pressure. Refer to Procedure 1003: King Safety Cable™ Selection (page 8).

Tip: Wear leather gloves when installing King Cable™ as there are several points when the installer could be pinched.

Process

Hose-to-Tool Installation (WSR1, WSR2, WSR3, and WSR4)

- 1. Loosen the cinch on the tool end of the cable (end without spring).
- 2. Loop the cable over the tool.
- 3. Tighten the cinch.
- 4. Open the loop on the hose end of the cable (spring side) and slide it over the hose connector.
- 5. Release the cable. The spring will tighten the cable on the hose.
- 6. Attach the hose connector to the tool.
- 7. Remove slack from the cable by sliding the cable loop as far away from the tool as possible.

Hose-to-Fixed Connector Installation (WSR1, WSR2, WSR3, & WSR4)

- 1. Loosen the cinch on the tool end of the cable (the end without a spring).
- 2. Loop the cable over the fixed connector.
Note: If the cable is intended to anchor the hose to the fixed connector, then the connector must be shaped so that the cable will not slip off in the event of a failure.
- 3. Release the cable. The spring will tighten the cable on the hose.
- 4. Open the loop on the hose end of the cable (the spring side) and slide it over the hose connector.
- 5. Tighten the cinch.
- 6. Attach the hose connector to the fixed connector.
- 7. Remove slack from the cable by sliding the cable loop as far away from the fixed connector as possible.

Hose-to-Hose Installation (WB1, WB2, WB3, and WB4)

- 1. Open the cable loop on one end and slide it over the coupling of one hose.
- 2. Open the cable loop on the other end and slide it over the coupling on the other hose.
- 3. Connect the hoses.
- 4. Remove slack by sliding the cable loops as far apart as possible and equidistant from the connection.

Procedure 2301: Installation of Dixon® Menders

effective 02/08

Selection

- 1. Select a mender based on hose ID (Inside Diameter). See current DPL (Dixon® Product List) for restrictions.
- 2. Select the correct style and size of clamp (pre-formed, band and buckle, double bolt). For pre-formed band clamps refer to Procedure 1001: Pre-formed Band Clamp Selection (page 6).

Notes

- 1. If the mender is to repair a damaged section of hose, cut 12" away from each side of the damaged area.
- 2. If the damage was the result of hose rupture due to excessive pressure, extreme temperature or incompatibility between the hose tube and the product being conveyed, replace the hose with one appropriate for the application. Do not use a mender.

Preparation

- 1. Prepare and mark the hose using Procedure 1100: General Preparation Instructions (pages 9-10).
- 2. Mark the middle of the mender.

Process

- 1. Insert the mender up to its midpoint into one piece of the hose.
- 2. Place the clamp(s) in its/their proper position.
- 3. Based on the style of clamp and installation method selected, use one of the following:
 - a. Procedure 2100: Installation of Pre-Formed Band Clamp Using Pneumatic Roll-Over Tool (page 20).
 - b. Procedure 2101: Installation of Pre-Formed Band Clamp Using Punch Style Tool (page 21).
 - c. Procedure 2103: Installation of Pre-Formed Band Clamp Using Screw-Action Tool with Roll-Over Tool Attachment (page 23).
 - d. Procedure 2104: Installation of Clamp-It Band and Buckle Using Screw-Action Tool (page 24).
 - e. Procedure 2201: Installation of Double Bolt Clamps, with saddles (page 26).
- 4. Insert the other end of the mender into the other piece of hose. Hose ends should make contact.
Note: If pre-formed band clamps are used, then they must be slid over the hose ends before the mender is inserted.
- 5. Place the clamp(s) in its/their proper position.
- 6. Install clamp(s) using the same procedure as used in step 3.
- 7. Check work using Procedure 3000: Criteria for Sufficient fit of Boss™ Clamp (page 49), 3001: Bolt Clamp Inspection (page 49-50) or 3002: Band Clamp Inspection (page 52).
- 8. Test assembly using Procedure 4000: General Hydrostatic Testing Information (page 60) and Procedure 4001 Hydrostatic Testing (page 61).

Procedure 2303: Installation of MIL H 29210C Steam Hose Assemblies

effective 02/08

Select

- Select Boss™ clamp using Procedure 1000: Boss™ Clamp Selection (page 5).

Preparation

- Prepare the hose using Procedure 1100: General Preparation Instructions (pages 9-10).

Process

- 1. Cut liner the same length as the hose.
- 2. Remove sharp edges from both ends.
- 3. At one end of the liner, create a hole in the first spiral.
- 4. Cut a length of wire 2' to 3' longer than the hose.
- 5. Insert one end of the wire into the hole and secure.
- 6. Feed the other end into the hose until it comes out the opposite end.
- 7. Begin twisting the liner clockwise to reduce its diameter.
- 8. Lubricate the first 1' to 2' of the OD (Outside Diameter) of the liner with talcum powder.
- 9. Insert the liner into the hose.
- 10. Pull the wire through the hose while simultaneously twisting and lubricating the liner.
- 11. Continue inserting the liner until 1½" to 2" are visible at both ends.
- 12. Disconnect the wire from the liner.
- 13. Thread the spiraled end of the coupling into the liner fully.
- 14. Insert the coupling into the hose until it contacts the stem collar. Refer to step 9 of Procedure 1100: General Preparation Instructions (pages 9-10).
- 15. Repeat steps 13 and 14 for the other end of hose.
- 16. Place the stem in a vise. For male stems, tighten vise on hex. For female stems (wing nut), place a spud in a vice, tighten and then thread the wing nut onto the spud.
Note: Always secure the stem in a vise before tightening the clamp bolts. Failure to do so may result in separation of the stem and the metal liner, damage to the metal liner or the hose tube and/or an assembly that leaks.
- 17. Installing the Boss™ clamp on a MIL H 29210C hose assembly requires:
 - a. 4 bolt clamps for a hose with an ID (Inside Diameter) of 1" and above.
Use Procedure 2001: Installation of Boss™ 4 Bolt Clamps (page 16).
 - b. 2 bolt clamps for a hose with a ID less than 1".
Use Procedure 2000: Installation of Boss™ 2 Bolt Clamps (page 15).
- 18. Test assembly using Procedure 4000: General Hydrostatic Testing Information (page 60) and Procedure 4001: Hydrostatic Testing (page 61).
- 19. Prepare for shipment. When coiling the assembly, never coil the hose smaller than the hose manufacturer's recommended minimum bend radius. Doing so can cause the stem and liner to separate and damage the hose.
Tip: To "ball park" minimum band radius, multiply the hose ID x 12.
Example: 2" ID hose x 12 = 24" min band radius.

Procedure 2304: Installation of Brass Stems and Ferrules using 5111A and 1765A Tools

effective 02/08

Preparation

- 1. Prepare the hose using Procedure 1100: General Preparation Instructions (pages 9-10).
- 2. For Information concerning selection of the proper ferrule and die, as well as setting up 5111A/1765A Crimping Machines using Procedure 1103: Set-up 5111A /1765A Crimping Machine (page 14).

Notes

- 1. Dixon® recommends the 5111A tool be mounted on a table leg, storage rack leg or wall at waist height for maximum leverage.
- 2. BFL and BFM style ferrules are for air or water service. BF, BFW, and BFMW style ferrules are for water service ONLY.

Procedure

- 1. Slide the ferrule over the hose.
- 2. Insert the coupling. Refer to step 9 of Procedure 1100: General Preparation Instructions (pages 9-10).
- 3. *For the 5111A tool:*
 - a. Lift the handle to open the dies.
 - b. Slide the hose with the stem and ferrule through dies to its proper position.
Use Procedure 1103: Set-up 5111A /1765A Crimping Machine (page 14).
 - c. Push down on the tool handle so that the dies fully close then open up.
Note: It is important for the tool to complete its 'cycle' of open-closed-open in one downward stroke of the handle to ensure proper crimping.
 - d. Remove the assembly from the tool.
- 4. *For the 1765A tool:*
 - a. Insert the hose with the stem and ferrule through the dies until the stem contacts the stop.
 - b. Depress the foot pedal to crimp the ferrule.
 - c. Release the foot pedal.
 - d. Remove the assembly from the tool.
- 5. Test the assembly using Procedure 4000: General Hydrostatic Testing Information (page 60) and Procedure 4001: Hydrostatic Testing (page 61).

Procedure 2305: Installation of Brass Reusable Fittings

effective 02/08

Selection

- Select the proper fitting using Procedure 1002: Brass Reusable Fitting Selection (page 6).

Preparation

- Prepare the hose using Procedure 1100: General Preparation Instructions (pages 9-10).

Procedure

Male and Female

- 1. Unthread the ferrule from the stem.
- 2. Slide the ferrule onto the hose until it contacts the hose end. *Note:* The hose must be cut square!
- 3. Place a mark on the hose at the junction of the hose and the ferrule.
- 4. Place the hose with the ferrule in a vise and tighten the vise on the flats of the ferrule. Make sure that the mark is visible.
Note: Do not over-tighten the vise. Too much tension will 'egg' the ferrule.
- 5. Insert the stem into the hose until the stem threads contact the ferrule.
- 6. Tighten the stem as follows:
 - a. Turn clockwise two to three turns.
 - b. Turn counter-clockwise one turn.
 - c. Repeat 'a' and 'b' until the stem hex contacts the ferrule.
- 7. With the fitting still in the vise, measure the distance from the mark to the end of the ferrule. If it is:
 - a. $\frac{1}{8}$ " or less; remove the assembly from the vise. It is properly assembled.
 - b. Greater than $\frac{1}{8}$ "; remove (unthread) the stem from the ferrule. Repeat step 2-6.
- 8. Test assembly using Procedure 4000: General Hydrostatic Testing Information (page 60) and Procedure 4001: Hydrostatic Testing (page 61).

Hose Splicers

- 1. Unthread both ferrules from the stem.
- 2. Slide the ferrule onto one hose until it contacts hose end. *Note:* The hose must be cut square!
- 3. Place a mark on the hose at the junction of the hose and the ferrule.
- 4. Place the hose with ferrule in a vise and tighten the vise on the flats of the ferrule. Make sure that the mark is visible.
Note: Do not over-tighten vise. Too much tension will 'egg' the ferrule.
- 5. Insert the stem into the hose until the stem threads contact the ferrule.
- 6. Tighten the stem as follows:
 - a. Turn clockwise two to three turns.
 - b. Turn counter-clockwise one turn.
 - c. Repeat 'a' and 'b' until the stem hex contacts the ferrule.
- 7. With the fitting still in the vise, measure the distance from the mark to the end of the ferrule. If it is:
 - a. $\frac{1}{8}$ " or less, it is properly assembled.
 - b. Greater than $\frac{1}{8}$ ", remove (unthread) the stem from the ferrule. Repeat step 2-6.
- 8. When the fitting is properly assembled, repeat steps 2 and 3 above for the other hose end.
- 9. With the properly assembled fitting in the vise, repeat step 5 above for the other end.
- 10. Tighten the ferrule onto stem as per steps 6a through 6c above. *Note:* The hose must rotate with ferrule.
- 11. Inspect the fitting, as per step 7 above.
- 12. Test assembly using Procedure 4000: General Hydrostatic Testing Information (page 60) and Procedure 4001: Hydrostatic Testing (page 61).

Procedure 2306: Crimping Uni-Range, Air King™ (WF), Dix-Lock™ (WF), and Dual-Lock (WF) Couplings

effective 06/16

Selection

- Select the proper fitting using the current DPL (Dixon® Product List).

Preparation

- 1. Prepare the hose using Procedure 1100: General Preparations Instructions (pages 9-10).
- 2. Measure the hose OD (Outside Diameter) at each end using Procedure 1101: How to Use a Dixon® Diameter Tape (page 11).
Tip: Mark hose OD on the hose after measuring to avoid mistakes on crimp dimensions/sleeve selection.
- 3. Determine the proper crimp diameter and crimp length from the appropriate Recommendation Guide in the current DPL.
- 4. Using a scale or caliper, measure inside the fitting from the end of the ferrule to the stem collar. This is the insertion depth.

Process

- 1. Depending upon the type of crimping machine used, set the crimp diameter or select the appropriate die cage and spacers.
- 2. Starting from the hose end, measure and mark the insertion depth on the hose.
- 3. Insert the coupling into the hose until the end of the ferrule reaches that mark on the hose.
- 4. Measuring from the square end of the ferrule, mark a crimp length line on it.
- 5. Insert the coupling through the crimper die segments and align the crimp length line with the end of the die segments.
- 6. Jog the machine until the die segments lightly contact the ferrule. It is important to adjust the fitting, if necessary, to ensure the crimp length line is at the end of die segments.
- 7. With light pressure, push the hose on to the fitting to ensure the stem collar is contacting the ferrule.
- 8. Activate the crimper until the desired crimp diameter is achieved.
- 9. Reverse the machine and remove the coupling.
- 10. Measure the crimp diameter with dial calipers or micrometer. If the crimp diameter is within ± 0.010 , the assembly is acceptable.
Tip: Crimp all hose ends having the same OD to speed up crimping process by not having to continually change crimper specifications. Use crimp die closest to crimp diameter without going over for best results (ex. crimp diameter 31mm, use 30mm die).
- 11. Crimp diameters that are outside the ± 0.010 tolerance must be evaluated further by using the Percent of Reduction Formula found in the Holedall™ Die Chart:
 - a. If the diameter is too large: Calculate the percent (%) reduction using the formula found in the Holedall™ Die Chart. If the result is between 18% to 24%, the crimp is acceptable. If it is less than 18%, re-crimp the ferrule until the specified crimp diameter is achieved. When the percent reduction is below 18% the assembly may leak or the hose and coupling may separate. Contact Dixon® at 877-963-4966 if questions arise.
 - b. If the diameter is too small: Calculate the percent (%) reduction using the formula found in the Holedall™ Die Chart. If the result is between 18% to 24%, the crimp is acceptable. If it is greater than 24%, contact Dixon® at 877-963-4966. The hose and/or coupling may have been damaged.
- 12. Test the assembly using Procedure 4000: General Hydrostatic Testing Information (page 60) and Procedure 4001: Hydrostatic Testing (page 61).

Procedure 2307: Air King™ Crimp with Light Duty Ferrules

effective 06/16

Selection

- 1. Measure the OD (Outside Diameter) of each end of the hose with a diameter tape.
Tip: Mark hose OD on the hose after measuring to avoid mistakes on crimp dimensions/sleeve selection.
- 2. From the current Dixon® Product List (DPL), select the correct ferrule for the hose OD just measured.

Preparation

- 1. Prepare the hose using Procedure 1100: General Preparation Instructions (pages 9-10).

Notes

- 1. Each end of the hose to be assembled must be measured accurately.
- 2. Crimp diameters can be located in the current DPL or by calling 877-963-4966.
- 3. Hold the finished crimp diameter for 3 to 5 seconds. This allows the metal to retain its new diameter.
Tip: Use the crimp die closest to the crimp diameter without going over for the best results (ex. crimp diameter 31mm, use 30mm die).
- 4. Finished crimp diameter must be measured for each fitting. Tolerance is ± 0.010 " from published crimp diameter.
- 5. If the finished crimp diameter is larger than the tolerance, re-crimp. If the crimp diameter is smaller than the tolerance, consult Dixon®.

Process

- 1. Slide the ferrule over the hose until the turnover end contacts the hose end.
- 2. Insert the fitting to the locking groove.
- 3. Set the crimp diameter on the crimper.
- 4. Bring the hose with the fitting and ferrule through the back of the crimper so that it is facing the operator.
- 5. Slowly jog the dies closed. Make sure the dies clear the Air King™ head.
- 6. Position the ferrule so the turnover end is even with the end of the crimp dies.
- 7. Slowly close the dies until they just contact the ferrule. Make positioning adjustments if necessary.
- 8. Push the Air King™ hose stop against the turnover end of the ferrule, making sure the dies clear the coupling.
- 9. Close the dies until the machine has reached the set crimp diameter and hold for 3 to 5 seconds.
- 10. Open the dies, pull the assembly forward and measure the crimp diameter.
Tip: Crimp all hose ends having the same OD to speed up the crimping process by not having to continually the change crimper specifications.
- 11. Inspect the ferrule for folds and creases and to ensure the ferrule engages the locking groove.



Procedure 2308: Connecting Vent-Lock™ Safety Cam and Groove Couplings

effective 1/16

Preparation

- 1. Prepare the hose using Procedure 1100: General Preparation Instructions (pages 9-10).

Notes

- 1. The Vent-Lock™ system prevents the accidental uncoupling of the fitting while under pressure. If the cam arms are accidentally opened while the assembly is still under pressure, the pressure will be released but the coupling will stay attached (see note on 9 below).
- 2. Blocking tabs prevent the cam arms from closing until the coupling is rotated to the safety position.
- 3. The Vent-Lock™ system is intended to protect you from an accidental uncoupling of the fittings while under pressure. Always remove the pressure from your system before attempting to uncouple the fitting. If you uncouple the fitting and find it difficult to rotate for removal, stop and verify that the pressure has been removed.
- 4. Residual pressure left in an assembly or induced by temperature changes can still cause injuries. When the Vent-Lock™ fitting is un-coupled, residual pressure and product will vent through the coupling. Always wear personal protective equipment appropriate for the product in use. 
- 5. Does not interchange with standard cam and groove products; use only with Vent-Lock™ L-style fittings! 
- 6. Rated up to **250 PSI** at ambient temperature (**70°F**) with standard Buna-N seal installed. For use at elevated temperatures or other unusual operating conditions, consult Dixon®.
- 7. 1", 1½" and 2" sizes have a maximum working pressure of **250 PSI**.
- 8. 3" maximum working pressure **150 PSI** with King Crimp™ ferrules; **125 PSI** with King Crimp™ Sleeves.
- 9. The 1" size does not vent above **140 PSI**. You will need to manually release the pressure from the assembly safely from another valve.

Process

To connect:

- 1. Open the arms on the coupler.
- 2. Align the arms with the machined grooves in the adapter.
- 3. Insert the adapter into the coupler.
- 4. Rotate the adapter 90°.
- 5. Close both arms at the same time.

To disconnect:

- 1. Confirm the pressure is released from the assembly.
- 2. Open one handle at a time.
- 3. Rotate the adapter 90° to align the cam arms with the machined grooves in the adapter.
- 4. Remove the adapter.

If the cam arms are accidentally opened on a pressurized assembly:

- 1. Locate and shut off the supply valve to the assembly.
- 2. After the pressure is vented from the assembly, rotate the coupler 90° to align the arms with the machined grooves in the adapter.
- 3. Disconnect the assembly.

Inspect the couplings for damage using Procedure 3003: Inspecting Dixon® Cam and Groove Couplings (pages 52-53).

Procedure 2309: Connecting EZLink™ Armless Cam and Groove Couplings

effective 6/16

Preparation

- 1. Prepare the hose using Procedure 1100: General Preparation Instructions (pages 9-10).
- 2. Follow Procedure 3006: Inspecting Dixon® EZLink™ Armless Cam and Groove Couplings (page 36).

Notes

- 1. Coupler tabs cannot be pushed to disconnect when pressurized to **20 PSI** or over.
- 2. Coupler push tabs can be locked with safety clip and/or zip tie, if required.
- 3. Prior to connecting, inspect the position of the coupler tabs, as they will be in the same position once full engagement occurs with coupling connection.
- 4. Contact Dixon® at 877-963-4966 for recommended working pressure and temperatures.

Process

To connect:

- 1. Place the tabs in the 6 o'clock position to allow for a user friendly connection. You can use the hose assembly as leverage to assist with connecting and disconnecting.
- 2. Push the coupler onto to the adapter, focusing pressure on one tab at a time. You will hear a click as each tab locks onto the adapter (If you see any orange on the tab, the tab is not locked on).
- 3. A locking clip and/or zip tie can be used if a positive lock is required.

To disconnect:

- 1. *Confirm the pressure is released from the assembly.*
- 2. *Release one tab at a time by pressing in on the tab.*
- 3. *Remove the coupler.*

Procedure 2400: King Crimp™ with Sleeves

effective 06/16

Selection

- 1. Measure the OD (Outside Diameter) of each end of the hose with a Dixon® diameter tape.
Tip: Mark hose OD on the hose after measuring to avoid mistakes on crimp dimensions/sleeve selection.
- 2. From the current Dixon® Product List (DPL), select the correct sleeve for the hose OD just measured.

Preparation

- 1. Prepare the hose using Procedure 1100: General Preparation Instructions (pages 9-10).

Notes

- 1. Each end of the hose to be assembled must be measured accurately.
- 2. Crimp diameters can be located in the current DPL, on the sleeve or by calling Dixon® at 877-963-4966.
- 3. Hold the finished crimp diameter for 3 to 5 seconds. This allows the metal to retain its new diameter.
- 4. Finished crimp diameter must be measured for each fitting. Tolerance is ± 0.010 " from published crimp diameter.
- 5. If the finished crimp diameter is larger than tolerance, re-crimp. If the crimp diameter is smaller than tolerance, consult Dixon®.
- 6. Consult Dixon® for coupling working pressures and for working pressures above **70°F (21°C)**.
Tip: Use the crimp die closest to crimp diameter without going over for the best results (ex. crimp diameter 31mm, use 30mm die).

Process

- 1. Slide the sleeve over the hose.
- 2. Insert the fitting into locking groove shoulder of the couplers and adapters. For King™ Combination nipples, insert to flat before the locking groove. Do not over insert.
- 3. Set the crimp diameter on the crimper.
- 4. Bring the hose with fitting and sleeve through the back of the crimper so that it is facing the operator.
- 5. Slowly jog dies closed. Make sure the dies clear the coupler head, adapter hose stop or King™ Combination nipple body.
- 6. Position the sleeve even with the dies.
- 7. Slowly close the dies until they just contact the sleeve. Make positioning adjustments if necessary.
- 8. Push the coupler head or adapter hose stop against the dies. For King™ Combination nipples, line up the back edge of the locking groove (the edge closest to body) with the end of the sleeve. Make sure the fitting clears the dies.
- 9. Close the dies until the machine has reached the set crimp diameter and hold for 3 to 5 seconds.
- 10. Open the dies, pull the assembly forward and measure the crimp diameter.

Tip: Crimp all hose ends having the same OD to speed up the crimping process by not having to continually change crimper specifications.

Procedure 2401: King Crimp™ with Ferrules

effective 06/16

Selection

- 1. Measure the OD (Outside Diameter) of each end of the hose with a Dixon® diameter tape.
Tip: Mark hose OD on the hose after measuring to avoid mistakes on crimp dimensions/sleeve selection.
- 2. From the current Dixon® catalog, select the correct ferrule for the hose OD just measured.

Preparation

- 1. Prepare the hose using Procedure 1100: General Preparation Instructions (pages 9-10).
- 2. For 6" ferrules and larger, place a mark on the shank $\frac{5}{16}$ " (0.312") from last serration. This is the insertion depth (See illustration below).

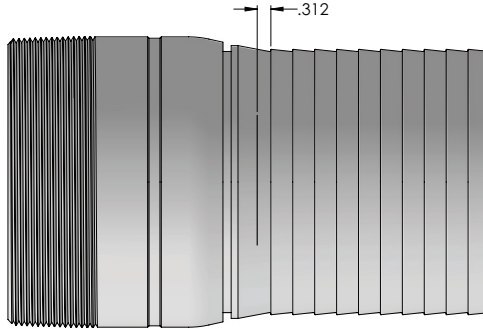

Notes

- 1. Each end of the hose to be assembled must be measured accurately.
- 2. $\frac{5}{16}$ " (0.312") insertion depth may need adjustment based upon hose construction and the presence or absence of metal reinforcement.
- 3. Crimp diameters are in the current Dixon® Product List (DPL), on the ferrule or by calling Dixon® at 877-963-4966.
- 4. Hold the finished crimp diameter for 3 to 5 seconds. This allows the metal to retain its new diameter.
- 5. Finished crimp diameter must be measured for each fitting. Tolerance is ± 0.010 " from published crimp diameter.
Tip: Use the crimp die closest to crimp diameter without going over for the best results (ex. crimp diameter 31mm, use 30mm die).
- 6. If the finished crimp diameter is larger than tolerance, recrimp. If the crimp diameter is smaller than tolerance, consult Dixon®.
- 7. Consult the King Crimp™ Pressure Recommendation Chart or Dixon® for coupling working pressures and for working pressures above **70°F (21°C)**.

Process

- 1. Slide the ferrule over the hose until the turnover end contacts the hose end.
- 2. Insert the fitting into locking groove or insertion depth mark.
- 3. Set the crimp diameter on the crimper.
- 4. Bring the hose with fitting and ferrule through the back of the crimper so that it is facing the operator.
- 5. Slowly jog dies closed. Make sure the dies clear the coupler head, adapter hose stop or King™ Combination nipple body.
- 6. Position the ferrule so the turnover end is even with the end of the crimp dies.
- 7. Slowly close the dies until they just contact the ferrule. Make positioning adjustments if necessary.
- 8. Push the coupler head, adapter hose stop or King™ Combination nipple locking groove shoulder against the turnover end of the ferrule making sure the dies clear the coupling.
- 9. Close the dies until the machine has reached the set crimp diameter and hold for 3 to 5 seconds.
- 10. Open the dies, pull the assembly forward and measure the crimp diameter.
Tip: Crimp all hose ends having the same OD to speed up the crimping process by not having to continually change crimper specifications.
- 11. Inspect the ferrule for folds and creases and to ensure the gripping fingers engage the locking groove.

Procedure 2402: Cam and Groove Coupling to Adapter

effective 07/16

Preparation

- 1. Verify the assembly's intended pressure is within the working pressures as defined in Procedure 4002: Test Pressures and Procedures for Cam and Groove Couplings (page 61).
- 2. Inspect the fittings for damage per Procedure 3003: Inspecting Dixon® Cam and Groove Couplings (pages 53-54).

Notes

- 1. Cam and groove couplings utilize one, two or four "cam arms" to leverage compression of the gasket between the adapter and the coupler.
- 2. When possible, the cam arms should be closed simultaneously using hand force only.
- 3. The use of hammers, or striking the cam arm with other objects, can weaken or damage the fitting.
- 4. Couplings are available in several configurations, some with the ability to lock the cam arms in a closed position, and some requiring the user to provide additional locking devices.
- 5. If the cam arms are not fully closed during assembly, they are at risk of opening unexpectedly while under pressure or during process-induced vibration.
- 6. Opening a cam arm assembly while under pressure can create a violent release of energy and induce damage to life, limb and/or property.

Process

To Connect:

- 1. Open the arms on the coupler.
- 2. Visually verify the presence of a gasket within the coupler.
- 3. Insert the adapter into the coupler fully until it contacts the gasket.
- 4. Using hands only, evenly close both cam arms fully (make sure the pull ring is not obstructing full closure).
- 5. On four-arm models, close the remaining two cam arms.
- 6. Visually examine the assembly to assure that all cam arms are in the fully-closed position.
- 7. Install locking feature, if present.

To Disconnect:

- 1. Confirm that all pressure has been removed from the assembly. Do not disconnect the coupling while pressure remains in the system.
- 2. Remove any locking device previously installed or lift the release lever of the EZ Boss™ Lock style cam arms.
- 3. Open one cam arm at a time. If any pressure remains in the system, opening only one cam arm could provide an audible warning of pressure and allow the operator the opportunity to re-close the arm and take appropriate steps to de-pressurize the system.
- 4. Open the remaining arm(s) and remove the adapter from the coupling.

Procedure 2403: Assembling Cam and Groove Flanged Adapters

effective 10/16

Preparation

- 1. Verify the assembly's intended pressure is within the working pressures as defined in Procedure 4002, Test Pressures & Procedures for Cam and Groove Couplings (page 62).
- 2. Inspect the fittings for damage per Procedure 3003: Inspecting Dixon® Cam and Groove Couplings (pages 53-54).
- 3. Inspect the flange end of the fitting for excessive damage to the mating surface. Minor dings in the sealing surface are acceptable, but any raised bumps or contamination that would prevent the normal compression of the gasket are cause for rejection or rework.
- 4. Inspect the bolts and nuts for damaged threads or incomplete threads. That damage could provide false torque readings and a lower clamping pressure. Bolts must be long enough to provide a full nut when assembled.
- 5. Cam and groove product typically has a lower working pressure than the rating for a 150# flange. Flanges on some cam and groove flange adapters have been lightened to provide the necessary cam and groove working pressure.
- 6. Reference ASME PCC-1 for flange assembly instructions. Torque values in the specification typically exceed those necessary for acceptable cam and groove assemblies. The user should tighten the assembly enough to achieve an acceptable seal but not enough to distort the flange.

Notes

- 1. Do not re-use gaskets. 
- 2. If there is an alignment problem between the two flanges, do not use the bolts to correct that condition. Align the mating flanges correctly before tightening the nuts.
- 3. Refrain from using air assisted or electric impact tools as they make it harder to evenly tighten the assembly and can lead to flange damage and/or lower sealing performance.
- 4. Disassembly of a flanged connection should occur in a similar manner to the tightening described below (slowly and sequentially). Make sure all pressure, including head pressure, has been removed from the system before beginning the disassembly process.

Process

To Connect:

- 1. Select the correct gasket, bolts and nuts for your assembly. Verify their condition as per "Preparation."
- 2. Position the gasket correctly on one flange. If adhesive is necessary, it should be applied to the gasket, not to the flange. The gasket should not extend into the ID (Internal Dimension) of the flange but be evenly centered on the flange face.
- 3. Install the bolts and nuts, all facing in the same direction, with the nuts on the side of easiest access for tightening and inspection. Only tighten the nuts hand tight until all are installed and the flanges have an even gap all the way around.
- 4. Follow the correct tightening sequence when tightening nuts. The torques should be applied gradually, first approximately 20% of the desired final torque.
- 5. Inspect the assembly for an even gap around the perimeter of the flanges. Adjust for an even gap by tightening or loosening nuts as necessary. Readjust all to achieve an even gap and uniform torque at around 20% of the desired level. Remember, all tightening should be done in the specified sequence.
- 6. Repeat that step, taking the torque to between 50% and 70% of the desired torque level. Again inspect for an even gap and adjust as necessary.
- 7. Repeat this step, taking the torque to 100% of the desired level and inspect for evenness, adjusting if necessary.
- 8. Repeat this step once more, again torquing all nuts to 100% of the desired level.
- 9. If possible, wait several hours, then re-torque all nuts using the correct sequence. This will overcome any loosening brought on from gasket creep.

Procedure 2500: Crimp Boss™ Steam - 3/4" Continental Contitech Flexsteel® 250 Hose

effective 08/18

Preparation

- 1. Cut ends square: Hose ends must be cut square (90° to the length of the hose) for proper coupling insertion. Improper insertion can reduce coupling retention.
- 2. Clean hose ends: Debris left inside the hose from the cutting process must be removed prior to coupling insertion. This is especially important when an abrasive wheel or 'chop saw' is used to make the cut. Debris will reduce coupling retention.

Process

- 1. Slide the ferrule CSTF075-1330 over the hose until the turnover end contacts the hose end.
- 2. Place wing nut B12 on stem CSTS-075.
- 3. Insert the stem and nut combination into the hose until the stem bottoms out on the hose.
- 4. Set the crimp diameter on the crimp machine so it produces a final diameter of 1.380" (+/- .007) on the ferrule.
- 5. Use the crimp dies that are sized so the low end of their crimp diameter is slightly smaller than the final diameter of the ferrule.
- 6. Bring the hose with wing nut, stem, and ferrule through the back of the crimper so it is facing the operator.
- 7. Slowly jog the dies closed, and make sure the dies clear the wing nut.
- 8. Position the ferrule so the turnover is setback - 1/8" from the edge of the crimp dies.
- 9. Slowly close the dies until they just contact the ferrule. Make positioning adjustments if necessary.
- 10. Make sure the hose is in contact with the hose stop on the stem and the ferrule is aligned with the locking groove and the dies clear the wing nut.
- 11. Close the dies until the machine has reached the set crimp diameter and hold for 3 to 5 seconds.
- 12. Open the dies, pull the assembly forward and measure the crimp diameter between the grooves using calipers.
- 13. If the ferrule diameter does not fall within the required diameter range, then adjust the crimp machine and repeat steps 11 and 12; otherwise move on to step 14. (Refer to Note #1 if the ferrule needs to be re-crimped.)
- 14. Inspect the assembly to ensure the ferrule is in the locking groove, the entire length is crimped and the wing nut seats properly.

Notes

- 1. Although not necessary, Dixon® recommends turning the assembly halfway through the crimp process so the ribs on the ferrule are centered in each of the crimp dies. This reduces the spines on the ferrule caused by the gaps between the die, and more uniformly distributes the clamping force of the ferrule on the hose.
- 2. Finished crimp diameter must be measured for each fitting.
- 3. If the finished crimp diameter is larger than tolerance, re-crimp. If the crimp diameter is smaller than tolerance, consult Dixon®.
- 4. Dixon® recommends hydrostatically proof testing all assemblies at working pressure and 2x working pressure to assure proper assembly.
- 5. This document covers assembly for the 3/4" Continental Contitech Flexsteel® 250 Hose only.

Procedure 2501: Crimp Boss™ Steam - 1" Texcel® Tex-Steam Hose

effective 08/18

Preparation

- 1. Cut ends square: Hose ends must be cut square (90° to the length of the hose) for proper coupling insertion. Improper insertion can reduce coupling retention.
- 2. Clean hose ends: Debris left inside the hose from the cutting process must be removed prior to coupling insertion. This is especially important when an abrasive wheel or 'chop saw' is used to make the cut. Debris will reduce coupling retention.

Process

- 1. Slide the ferrule CSTF100-1700 over the hose until turnover end contacts the hose end.
- 2. Place wing nut B12 on stem CSTS-100.
- 3. Insert the stem and nut combination into the hose until the stem bottoms out on the hose.
- 4. Set the crimp diameter on the crimp machine so it produces a final diameter of 1.774" (+/- .008) on the ferrule.
- 5. Use crimp dies that are sized so the low end of their crimp diameter is slightly smaller than the final diameter of the ferrule.
- 6. Bring the hose with wing nut, stem, and ferrule through the back of the crimper so it is facing the operator.
- 7. Slowly jog the dies closed and make sure the dies clear the wing nut.
- 8. Position the ferrule so the turnover is setback - 1/8" from the edge of the crimp dies.
- 9. Slowly close the dies until they just contact the ferrule. Make positioning adjustments if necessary.
- 10. Make sure the hose is in contact with the hose stop on the stem and the ferrule is aligned with the locking groove and the dies clear the wing nut.
- 11. Close the dies until the machine has reached the set crimp diameter and hold for 3 to 5 seconds.
- 12. Open the dies, pull the assembly forward and measure the crimp diameter between the grooves using calipers.
- 13. If the ferrule diameter does not fall within the required diameter range, then adjust the crimp machine and repeat steps 11 and 12; otherwise move on to step 14. (Refer to Note #1 if the ferrule needs to be re-crimped.)
- 14. Inspect the assembly to ensure the ferrule is in the locking groove, the entire length is crimped and the wing nut seats properly.

Notes

- 1. Although not necessary, Dixon® recommends turning the assembly halfway through the crimp process so the ribs on the ferrule are centered in each of the crimp dies. This reduces the spines on the ferrule caused by the gaps between the die, and more uniformly distributes the clamping force of the ferrule on the hose.
- 2. Finished crimp diameter must be measured for each fitting.
- 3. If the finished crimp diameter is larger than tolerance, re-crimp. If the crimp diameter is smaller than tolerance, consult Dixon®.
- 4. Dixon® recommends hydrostatically proof testing all assemblies at working pressure and 2x working pressure to assure proper assembly.
- 5. This document covers assembly for 1" Texcel® Tex-Steam Hose only.

Procedure 2502: Crimp Boss™ Steam - 1½" Continental Contitech Flexsteel® 250 Steam Hose

effective 08/18

Preparation

- 1. Cut ends square: Hose ends must be cut square (90° to the length of the hose) for proper coupling insertion. Improper insertion can reduce coupling retention.
- 2. Clean hose ends: Debris left inside the hose from the cutting process must be removed prior to coupling insertion. This is especially important when an abrasive wheel or 'chop saw' is used to make the cut. Debris will reduce coupling retention.

Process

- 1. Slide the ferrule CSTF-150-2170 over the hose until the turnover end contacts the hose end.
- 2. Place wing nut B17 on stem CSTS-150.
- 3. Insert the stem and nut combination into the hose until the stem bottoms out on the hose.
- 4. Set the crimp diameter on the crimp machine so it produces a final diameter of 2.368" (+/- .010) on the ferrule.
- 5. Use crimp dies that are sized so the low end of their crimp diameter is slightly smaller than the final diameter of the ferrule.
- 6. Bring the hose with wing nut, stem, and ferrule through the back of the crimper so it is facing the operator.
- 7. Slowly jog the dies closed, and make sure the dies clear the wing nut.
- 8. Position the ferrule so the turnover is setback - ⅛" from the edge of the crimp dies.
- 9. Slowly close the dies until they just contact the ferrule. Make positioning adjustments if necessary.
- 10. Make sure the hose is in contact with the hose stop on the stem and the ferrule is aligned with the locking groove and the dies clear the wing nut.
- 11. Close the dies until the machine has reached the set crimp diameter and hold for 3 to 5 seconds.
- 12. Open the dies, pull the assembly forward and measure the crimp diameter between the grooves using calipers.
- 13. If the ferrule diameter does not fall within the required diameter range, then adjust the crimp machine and repeat steps 11 and 12; otherwise move on to step 14. (Refer to Note #1 if the ferrule needs to be re-crimped.)
- 14. Inspect the assembly to ensure the ferrule is in the locking groove, the entire length is crimped and the wing nut seats properly.

Notes

- 1. Although not necessary, Dixon® recommends turning the assembly halfway through the crimp process so the ribs on the ferrule are centered in each of the crimp dies. This reduces the spines on the ferrule caused by the gaps between the die, and more uniformly distributes the clamping force of the ferrule on the hose.
- 2. Finished crimp diameter must be measured for each fitting.
- 3. If the finished crimp diameter is larger than tolerance, re-crimp. If the crimp diameter is smaller than tolerance, consult Dixon®.
- 4. Dixon® recommends hydrostatically proof testing all assemblies at working pressure and 2x working pressure to assure proper assembly.
- 5. This document covers assembly for 1½" Continental Contitech Flexsteel® 250 Steam Hose only.

Procedure 2503: Crimp Boss™ Steam - 1" Continental Contitech Flexsteel® 250 Hose

effective 12/18

Preparation

- 1. Cut ends square: Hose ends must be cut square (90° to the length of the hose) for proper coupling insertion. Improper insertion can reduce coupling retention.
- 2. Clean hose ends: Debris left inside the hose from the cutting process must be removed prior to coupling insertion. This is especially important when an abrasive wheel or 'chop saw' is used to make the cut. Debris will reduce coupling retention.

Process

- 1. Slide the ferrule CSTF100-1700 over the hose until the turnover end contacts the hose end.
- 2. Place wing nut B12 on stem CSTS-100.
- 3. Insert the stem and nut combination into the hose until the stem bottoms out on the hose.
- 4. Set the crimp diameter on the crimp machine so it produces a final diameter of 1.818" (+/- .007) on the ferrule.
- 5. Use crimp dies that are sized so the low end of their crimp diameter is slightly smaller than the final diameter of the ferrule.
- 6. Bring the hose with wing nut, stem, and ferrule through the back of the crimper so it is facing the operator.
- 7. Slowly jog the dies closed, and make sure dies clear the wing nut.
- 8. Position the ferrule so the turnover is setback - 1/8" from the edge of the crimp dies.
- 9. Slowly close the dies until they just contact ferrule. Make positioning adjustments if necessary.
- 10. Make sure the hose is in contact with the hose stop on the stem and the ferrule is aligned with the locking groove and the dies clear the wing nut.
- 11. Close the dies until the machine has reached the set the crimp diameter and hold for 3 to 5 seconds.
- 12. Open the dies, pull the assembly forward and measure the crimp diameter between the grooves using calipers.
- 13. If the ferrule diameter does not fall within the required diameter range, then adjust the crimp machine and repeat steps 11 and 12; otherwise move on to step 14. (Refer to Note #1 if the ferrule needs to be re-crimped.)
- 14. Inspect the assembly to ensure the ferrule is in the locking groove, the entire length is crimped and the wing nut seats properly.

Notes

- 1. Although not necessary, Dixon® recommends turning the assembly halfway through the crimp process so the ribs on the ferrule are centered in each of the crimp dies. This reduces the spines on the ferrule caused by the gaps between the die, and more uniformly distributes the clamping force of the ferrule on the hose.
- 2. Finished crimp diameter must be measured for each fitting.
- 3. If the finished crimp diameter is larger than tolerance, recrimp. If the crimp diameter is smaller than tolerance, consult Dixon®.
- 4. Dixon® recommends hydrostatically proof testing all assemblies at working pressure and 2x working pressure to assure proper assembly.
- 5. This document covers assembly for 1" Continental Contitech Flexsteel® 250 Hose only.

Procedure 2504: Crimp Boss™ Steam - 3/4" Gates 205MB Steam King® Hose

effective 08/18

Preparation

- 1. Cut ends square: Hose ends must be cut square (90° to the length of the hose) for proper coupling insertion. Improper insertion can reduce coupling retention.
- 2. Clean hose end: Debris left inside the hose from the cutting process must be removed prior to coupling insertion. This is especially important when an abrasive wheel or 'chop saw' is used to make the cut. Debris will reduce coupling retention.

Process

- 1. Slide the ferrule CSTF075-1330 over the hose until the turnover end contacts the hose end.
- 2. Place wing nut B12 on stem CSTS-075.
- 3. Insert the stem and nut combination into the hose until the stem bottoms out on the hose.
- 4. Set the crimp diameter on the crimp machine so it produces a final diameter of 1.357" (+/- .007) on the ferrule.
- 5. Use crimp dies that are sized so the low end of their crimp diameter is slightly smaller than the final diameter of the ferrule.
- 6. Bring the hose with wing nut, stem, and ferrule through the back of the crimper so it is facing the operator.
- 7. Slowly jog the dies closed, and make sure the dies clear the wing nut.
- 8. Position the ferrule so the turnover is setback - 1/8" from the edge of the crimp dies.
- 9. Slowly close the dies until they just contact the ferrule. Make positioning adjustments if necessary.
- 10. Make sure the hose is in contact with the hose stop on the stem and the ferrule is aligned with the locking groove and the dies clear the wing nut.
- 11. Close the dies until the machine has reached the set crimp diameter and hold for 3 to 5 seconds.
- 12. Open the dies, pull the assembly forward and measure the crimp diameter between the grooves using calipers.
- 13. If the ferrule diameter does not fall within the required diameter range, then adjust the crimp machine and repeat steps 11 and 12; otherwise move on to step 14. (Refer to Note #1 if the ferrule needs to be re-crimped.)
- 14. Inspect the assembly to ensure the ferrule is in the locking groove, the entire length is crimped and the wing nut seats properly.

Notes

- 1. Although not necessary, Dixon® recommends turning the assembly halfway through the crimp process so the ribs on the ferrule are centered in each of the crimp dies. This reduces the spines on the ferrule caused by the gaps between the die, and more uniformly distributes the clamping force of the ferrule on the hose.
- 2. Finished crimp diameter must be measured for each fitting.
- 3. If the finished crimp diameter is larger than tolerance, re-crimp. If the crimp diameter is smaller than tolerance, consult Dixon®.
- 4. Dixon® recommends hydrostatically proof testing all assemblies at working pressure and 2x working pressure to assure proper assembly.
- 5. This document covers assembly for 3/4" Gates 205MB Steam King® Hose only.

Procedure 2505: Crimp Boss™ Steam - ¾" Texcel® Tex-Steam Hose

effective 08/18

Preparation

- 1. Cut ends square: Hose ends must be cut square (90° to the length of the hose) for proper coupling insertion. Improper insertion can reduce coupling retention.
- 2. Clean hose ends: Debris left inside the hose from the cutting process must be removed prior to coupling insertion. This is especially important when an abrasive wheel or 'chop saw' is used to make the cut. Debris will reduce coupling retention.

Process

- 1. Slide the ferrule CSTF075-1330 over the hose until the turnover end contacts the hose end.
- 2. Place wing nut B12 on stem CSTS-075.
- 3. Insert the stem and nut combination into the hose until the stem bottoms out on the hose.
- 4. Set the crimp diameter on the crimp machine so it produces a final diameter of 1.446" (+/- .010) on the ferrule.
- 5. Use crimp dies that are sized so the low end of their crimp diameter is slightly smaller than the final diameter of the ferrule.
- 6. Bring the hose with wing nut, stem, and ferrule through the back of the crimper so it is facing the operator.
- 7. Slowly jog the dies closed, and make sure the dies clear the wing nut.
- 8. Position the ferrule so the turnover is setback - ⅛" from the edge of the crimp dies.
- 9. Slowly close the dies until they just contact the ferrule. Make positioning adjustments if necessary.
- 10. Make sure the hose is in contact with the hose stop on the stem and the ferrule is aligned with the locking groove and the dies clear the wing nut.
- 11. Close the dies until the machine has reached the set crimp diameter and hold for 3 to 5 seconds.
- 12. Open the dies, pull the assembly forward and measure the crimp diameter between the grooves using calipers.
- 13. If the ferrule diameter does not fall within the required diameter range, then adjust the crimp machine and repeat steps 11 and 12; otherwise move on to step 14. (Refer to Note #1 if the ferrule needs to be re-crimped.)
- 14. Inspect the assembly to ensure the ferrule is in the locking groove, the entire length is crimped and the wing nut seats properly.

Notes

- 1. Although not necessary, Dixon® recommends turning the assembly halfway through the crimp process so the ribs on the ferrule are centered in each of the crimp dies. This reduces the spines on the ferrule caused by the gaps between the die, and more uniformly distributes the clamping force of the ferrule on the hose.
- 2. Finished crimp diameter must be measured for each fitting.
- 3. If the finished crimp diameter is larger than tolerance, re-crimp. If the crimp diameter is smaller than tolerance, consult Dixon®.
- 4. Dixon® recommends hydrostatically proof testing all assemblies at working pressure and 2x working pressure to assure proper assembly.
- 5. This document covers assembly for ¾" Texcel® Tex-Steam Hose only.

Procedure 2506: Crimp Boss™ Steam - 1½" Gates 205MB Steam King® Hose

effective 08/18

Preparation

- 1. Cut ends square: Hose ends must be cut square (90° to the length of the hose) for proper coupling insertion. Improper insertion can reduce coupling retention.
- 2. Clean hose ends: Debris left inside the hose from the cutting process must be removed prior to coupling insertion. This is especially important when an abrasive wheel or 'chop saw' is used to make the cut. Debris will reduce coupling retention.

Process

- 1. Slide the ferrule CSTF-150-2240 over the hose until the turnover end contacts the hose end.
- 2. Place wing nut B17 on stem CSTS-075.
- 3. Insert the stem and nut combination into the hose until stem bottoms out on the hose.
- 4. Set the crimp diameter on the crimp machine so it produces a final diameter of 2.398" (+/- .010) on the ferrule.
- 5. Use crimp dies that are sized so the low end of their crimp diameter is slightly smaller than the final diameter of the ferrule.
- 6. Bring the hose with wing nut, stem, and ferrule through the back of the crimper so it is facing the operator.
- 7. Slowly jog the dies closed, and make sure the dies clear the wing nut.
- 8. Position the ferrule so the turnover is setback - ⅛" from the edge of the crimp dies.
- 9. Slowly close the dies until they just contact the ferrule. Make positioning adjustments if necessary.
- 10. Make sure the hose is in contact with the hose stop on the stem and the ferrule is aligned with the locking groove and the dies clear the wing nut.
- 11. Close the dies until the machine has reached the set crimp diameter and hold for 3 to 5 seconds.
- 12. Open the dies, pull the assembly forward and measure the crimp diameter between the grooves using calipers.
- 13. If the ferrule diameter does not fall within the required diameter range, then adjust the crimp machine and repeat steps 11 and 12; otherwise move on to step 14. (Refer to Note #1 if the ferrule needs to be re-crimped.)
- 14. Inspect the assembly to ensure the ferrule is in the locking groove, the entire length is crimped and the wing nut seats properly.

Notes

- 1. Although not necessary, Dixon® recommends turning the assembly halfway through the crimp process so the ribs on the ferrule are centered in each of the crimp dies. This reduces the spines on the ferrule caused by the gaps between the die, and more uniformly distributes the clamping force of the ferrule on the hose.
- 2. Finished crimp diameter must be measured for each fitting.
- 3. If the finished crimp diameter is larger than tolerance, re-crimp. If the crimp diameter is smaller than tolerance, consult Dixon®.
- 4. Dixon® recommends hydrostatically proof testing all assemblies at working pressure and 2x working pressure to assure proper assembly.
- 5. This document covers assembly for 1½" Gates 205MB Steam King® Hose only.

Procedure 2507: Steam Crimp – 1½" Texcel Tex-Steam Hose

effective 01/19

Preparation

- 1. Cut ends square: Hose ends must be cut square (90° to the length of the hose) for proper coupling insertion. Improper insertion can reduce coupling retention.
- 2. Clean hose ends: Debris left inside the hose from the cutting process must be removed prior to coupling insertion. This is especially important when an abrasive wheel or 'chop saw' is used to make the cut. Debris will reduce coupling retention.

Process

- 1. Slide the ferrule CSTF-150-2170 over the hose until the turnover end contacts the hose end.
- 2. Place wing nut B17 on stem CSTS-150
- 3. Insert the stem and nut combination into the hose until the stem bottoms out on the hose.
- 4. Set the crimp diameter on the crimp machine so it produces a final diameter of 2.303" (+/- .008) on the ferrule.
- 5. Use crimp dies that are sized so the low end of their crimp diameter is slightly smaller than the final diameter of the ferrule.
- 6. Bring the hose with wing nut, stem, and ferrule through the back of the crimper so that it is facing the operator.
- 7. Slowly jog the dies closed, and make sure the dies clear wing nut.
- 8. Position the ferrule so the turnover is setback ~ ⅛" from the edge of the crimp dies.
- 9. Slowly close the dies until they just contact the ferrule. Make positioning adjustments if necessary.
- 10. Make sure the hose is in contact with the hose stop on the stem and the ferrule is aligned with the locking groove and the dies clear the wing nut.
- 11. Close the dies until the machine has reached the set crimp diameter and hold for 3 to 5 seconds.
- 12. Open the dies, pull the assembly forward and measure the crimp diameter between the grooves using calipers.
- 13. If the ferrule diameter does not fall within the required diameter range then adjust the crimp machine and repeat steps 11 and 12; otherwise move on to 14. (Refer to Note #1 if the ferrule needs to be re-crimped.)
- 14. Inspect the assembly to ensure the ferrule is in the locking groove, the entire length is crimped and the wing nut seats properly.

Notes

- 1. Although not necessary, Dixon® recommends turning the assembly halfway through the crimp process so the ribs on the ferrule are centered in each of the crimp dies. This reduces the spines on the ferrule caused by the gaps between the die and more uniformly distributes the clamping force of the ferrule on the hose.
- 2. Finished crimp diameter must be measured for each fitting.
- 3. If the finished crimp diameter is larger than tolerance, re-crimp. If the crimp diameter is smaller than tolerance, consult Dixon®.
- 4. Dixon® recommends hydrostatically proof testing all assemblies at working pressure and 2x working pressure to assure proper assembly.
- 5. This document covers assembly for 1½" Texcel Tex-Steam Hose only.

Procedure 3000: Criteria For Sufficient Fit of a Boss™ Clamp

effective 02/08

Notes

- 1. Criteria for Sufficient Fit provides inspection guidelines for when the clamp has been assembled in accordance with the prescribed Procedure and all of the bolts are tightened to the correct torque value as stated on the Boss™ clamp page of the current DPL (Dixon® Product List).
- 2. Failure to adhere to these guidelines could produce poor clamp performance, leaking assemblies or even separation of hose and coupling that may cause property damage and/or serious injury to personnel.

Minimum Range

- 1. $\frac{1}{32}$ " clearance between clamp halves (both sides) for clamps designed to fit $\frac{1}{4}$ " ID (Inside Diameter) through 2" ID hose.
- 2. $\frac{1}{16}$ " clearance between clamp halves (both sides for 4 bolt clamps) or all segments (6 bolt clamps) for clamps designed to fit $2\frac{1}{2}$ " ID through 6" ID hose.
- 3. $\frac{1}{32}$ " clearance between clamp gripping fingers (all gripping fingers) and stem groove for all sizes.

Maximum Range

- 1. $\frac{1}{32}$ " interlock between clamp gripping finger and stem collar (all gripping fingers) for clamps designed to fit $\frac{1}{4}$ " ID through 2" ID hose.
- 2. $\frac{1}{16}$ " interlock between clamp gripping finger and stem collar (all gripping fingers) for clamps designed to fit $2\frac{1}{2}$ " ID through 6" ID hose.
- 3. $\frac{1}{32}$ " interlock between dovetail extensions (both sides) for clamps designed to fit $\frac{1}{4}$ " ID through 2" ID hose.
- 4. $\frac{1}{16}$ " interlock between dovetail extensions on both sides (4 bolt clamps) or all segments (6 bolt clamps) for clamps designed to fit $2\frac{1}{2}$ " ID through 6" ID hose.

Procedure 3001: Bolt Clamp Inspection

effective 06/16

Notes

- 1. Failure to correctly install clamps and inspect them on a regular basis could lead to assembly failure.  Assembly failure can result in damage to equipment and/or serious injury or death to personnel.
- 2. A number of factors can affect the integrity of an assembly. Some of these factors are: hose material (tube and cover), hose reinforcement material, reinforcement method, installation method, characteristics of the stem, clamp type, clamp material, product being conveyed, and/or its temperature. Consideration for these factors and others determines the type and frequency of inspections required to ensure that the assembly is safe.
- 3. If questions arise, contact Dixon® at 877-963-4966.

Process

All Bolt Clamps

- 1. Prior to initial use, check to ensure that the clamp is appropriate for the hose and application.
- 2. Prior to initial use, and at scheduled subsequent inspections, ensure that each clamp has its full complement of nuts and bolts. If any are missing, call an authorized Dixon® distributor or Dixon® at 877-963-4966. Replacing clamp nuts and bolts with other than those supplied by Dixon® could adversely affect the function of the clamp. 
- 3. Prior to use after storage, tighten all bolts to their recommended torque rating. For torque ratings, reference the product page in the current DPL (Dixon® Product List). Use the tightening sequence recommended in the appropriate Dixon® Procedure. Over tightening nuts can damage the bolt and/or clamp and affect its function.
- 4. After assembly of Boss™ clamps, Dixon® advises checking the torque setting daily for the first week, weekly for the first month and monthly thereafter.
- 5. Prior to initial use of the assembly, spray paint the junction of the hose and coupling.
Tip: Use a paint color that contrasts with the color of the coupling and the hose cover. Do not use silver paint.
- 6. Look for slippage between the hose and coupling prior to each use, during use and at each scheduled inspection. If 1/16" or more slippage has occurred or occurs, repair the assembly.
Note: If slippage has occurred, inspect the hose to determine suitability for returning it to service. Follow hose manufacturer's recommendations for determining hose serviceability.
Note: Some hoses exhibit 'stretch' while under pressure. This 'stretch' may appear to be slippage. To be certain, relieve the pressure in the assembly. If the 'slippage' indication disappears, stretch has occurred and the assembly can be returned to service. If the 'slippage' indication does not disappear, the assembly should be removed from service for repair or replacement.

...continued on next page

Procedure 3001: Bolt Clamp Inspection

(continued)

effective 02/08

Bolt Clamps without Gripping Fingers

- 1. Prior to each use or at each inspection interval, inspect:
 - a. Bolt lugs for cracks.
 - b. Bolt lugs for excessive wear (worn down to bolt hole).
 - c. Clamp bodies for cracks.
 - d. Clamp bodies for excessive wear (ex: Lettering detail "Dixon®" worn off).
 - e. For inadequate spacing between clamp halves (on clamps without saddles).
 - f. For inadequate spacing between clamp halves and the saddle loop (on clamps with saddles).
- 2. If any of the above conditions exist, do not use the assembly and remove the assembly from service.

Bolt Clamps with Gripping Fingers

- 1. Prior to each use or at each inspection interval, inspect:
 - a. Bolt lugs for cracks.
 - b. Bolt lugs for excessive wear (worn down to bolt hole).
 - c. Junction of bolt lugs and clamp body for cracks.
 - d. Clamp body for cracks.
 - e. Clamp body for excessive wear (Example: Lettering detail "Dixon®" worn off).
 - f. Gripping fingers for cracks.
 - g. Missing gripping fingers.
 - h. For adequate spacing between clamp halves.
 - i. For adequate spacing between the end of gripping fingers and the stem in the groove behind the collar.
- 2. If any of the above conditions exist, do not use the assembly and remove the assembly from service.

Procedure 3002: Band Clamp Inspection

effective 02/08

Notes

- 1. Failure to correctly install band clamps and inspect them on a regular basis could lead to an assembly failure. Assembly failure can result in damage to equipment and/or serious injury or death to personnel.
- 2. A number of factors can affect the integrity of an assembly. Some of these factors are: hose material (tube and cover), hose reinforcement material, reinforcement method, installation method, characteristics of the stem, clamp type, clamp material, product being conveyed and/or its temperature. Consideration for these factors and others determines the type and frequency of inspections required to ensure the assembly is safe.
- 3. If questions arise, contact Dixon® at 877-963-4966.

Process

- 1. Prior to initial use, check to ensure that the clamp is appropriate for the hose and application.
- 2. Prior to initial use of the assembly, spray paint the junction of the hose and coupling and the clamp buckles.
Note: Use a paint color that contrasts with the color of the coupling and the hose cover. Do not use silver paint.
- 3. Prior to each use, and monthly for assemblies that are in constant service (connected whether product is being conveyed or not), inspect the assembly as follows:
 - a. Inspect for slippage between the hose and coupling. If $1/16$ " or more slippage between the hose and coupling has occurred, repair the assembly before returning it to service.
Note: Some hoses exhibit 'stretch' while under pressure. This stretch may appear to be slippage. To be certain, relieve the pressure in the assembly. If the 'slippage' indication disappears, 'stretch' has occurred and the assembly can be returned to service. If the 'slippage' indication does not disappear, the assembly should be repaired or replaced.
 - b. Inspect for slippage at each clamp buckle. If $1/32$ " or more slippage at buckle has occurred, repair or replace the assembly.
 - c. Inspect the circumference (including buckle) of all bands for corrosion (rust). If the surface of any band appears pitted from corrosion, repair or replace the assembly.
 - d. Inspect the circumference (including buckle) of all bands for wear. If the worn area is less than 50% of the thickness of an unworn area, the assembly should be repaired or replaced.

Procedure 3003: Inspecting Dixon® Cam and Groove Couplings

effective 02/08

Notes

- 1. These procedures provide guidelines for determining the serviceability of used Dixon® cam and groove couplings.
- 2. Distributors or end users must not alter Dixon® products. Alterations include, but are not limited to: changing the shape or number of nodes or serrations, buffing, grinding, filing, drilling, cutting or welding any surface. If any such modifications are discovered in the inspection process, the product must be made inoperable and discarded.
- 3. During the inspection process, protective eyewear and rubber gloves should be worn at all times.
- 4. Assemblies made of previously used Dixon® cam and groove couplings must also be pressure tested.
Test the assembly using:
Procedure 4000: General Hydrostatic Testing Information (page 60),
Procedure 4001: Hydrostatic Test Procedure (page 60) and
Procedure 4002: Test Pressures for Boss-Lock™ Cam and Groove Couplings (page 62).
The distributor is responsible for maintaining test records.

Process

Coupler (styles B, C and D)

- 1. Examine the gasket area for nicks, gouges, scratches, dents, corrosion or pitting. If any of these conditions are present, discard the coupler.
- 2. Ensure that the coupler has a new gasket. The new gasket should be compatible with the material to be conveyed. For rubber gaskets supplied by Dixon®, the color and number of stripes on the side of the gasket identify the type. See cam and groove gaskets in the current DPL (Dixon® Product List). If there is any question about which gasket to install, call Dixon® at 877-963-4966 for a recommendation.
- 3. Examine the lobes of the cam arms for dents or excessive wear. If either of these conditions is present on either cam arm, replace both cam arms.
- 4. Check cam arms for free movement up-and-down as well as side-to-side. If either cam arm does not move freely, replace both cam arms.
- 5. Compare the cam arms to a new one to see if either of the existing ones are bent. If one or both are bent, replace both cam arms. If the cam arms are to be replaced, the pins must be replaced as well. Replace components with the same size and style that was removed.
- 6. Check the coupler for roundness by inserting a new adapter. If the adapter does not move freely in and out of the coupler, discard the coupler.
- 7. With the coupler in a vertical (up) position, insert the adapter until it contacts the gasket. In this situation, the cam arms should be at an approximately 90° angle to the coupler body. If the cam arms are less than 90°, replace both cam arms and pins and then re-inspect. If the cam arms are still not at 90°, discard the coupler.
- 8. For Boss-Lock™ couplers, examine both safety clip lugs. If either lug is bent or broken, or if the hole is closed, discard the coupler.

...continued on next page

Procedure 3003: Inspecting Dixon® Cam and Groove Couplings

(continued)

effective 02/08

- 9. Examine the other locking devices as follows:
 - a. Pull ring safety clips: Insert the clips on both cam arms into the hole in the lug. If either clip does not go through the hole, replace that pull ring safety clip.
 - b. EZ Boss-Lock™ handles: The locking device should activate immediately upon closure. Check this by closing the cam arms then pulling outward on the pull-rings. If one of the following conditions exists, replace the existing arms:
 - 1) Cam arm opens because a camshaft is bent.
 - 2) A spring is bent, broken or dysfunctional.
 - 3) Camshaft lever does not move freely when pulled down or return to its locked position freely when released.
 - 4) Cam arm is bent.
 - 5) Any condition that renders the locking devices inoperable.

Adapters (styles A, E and F)

- 1. Examine the sealing surface for nicks, cuts, scratches, dents or pitting. If any of these conditions are present, discard the adapter.
- 2. Examine the groove area for excessive wear or 'flat spots' (dents). If either of these conditions is present, discard the adapter.
- 3. Check the adapter for roundness by inserting it into a new coupler. If the adapter does not move freely in and out of the coupler, discard the adapter.

Hose Shanks (styles C and E)

- 1. Examine the nodes or serrations for any cuts, scratches, gouges or flat spots. If any of these conditions are present on any of the nodes or serrations, discard the coupling.
- 2. Examine the inside of the shank for pitting or corrosion. If either is present, discard the coupling.

Procedure 3004: Inspection and Maintenance of Food Grade Internal Expansion Plugs

effective 02/08

Note

- Proper inspection and maintenance of Food Grade Internal Expansion Plugs is essential for proper machine performance and satisfactory stem ID (Inside Diameter) surface finish. ID surface finish is critical in maintaining FDA/3A compliance.

Process

- 1. Examine the expansion plug surface for material build-up. The process of internally expanding stainless-steel couplings *will* leave deposits on the expansion plug. These deposits will be in the form of lines that run the length of the plug and a ring around the plug at its largest diameter. If these lines are present, the plug must be cleaned (see step 3). The more 'pulls' or times the expansion plug is used between cleanings, the greater the deposits become. This will result in the expansion machine having to work harder than necessary, poor stem ID surface finish and, ultimately, the plug getting stuck inside the stem before the expansion process is complete. When this occurs, major downtime and expense may be incurred.
- 2. Examine the expansion plug for surface scratches or dents. Minor surface scratches or dents usually do not pose a problem unless they are located in the largest diameter area of the plug. Scratches or dents in the largest diameter area of the plug can result in poor stem ID surface finish. If visible lines are produced on the stem ID as a result of these scratches or dents, the plug must be replaced.
- 3. Clean the expansion plug after each coupling expansion.
 - a. Use 200 to 400 grit wet/dry sandpaper for removing deposits from the expansion plug.
 - b. To remove deposits, wrap the sandpaper around half of the plug with one hand while holding the other half of the plug with the other hand.
 - c. Rotate the sandpaper back and forth several times until the deposits (lines and rings) are removed.
 - d. Repeat this process for the other half of the plug.

Procedure 3005: General Assembly Inspection

effective 02/08

Notes

- 1. The following procedure is to be used as a guideline for determining the serviceability of a hose assembly.
- 2. If coupling-related questions arise, contact Dixon® at 877-963-4966.
- 3. If hose-related questions arise, contact the hose manufacturer.

Process

Couplings

- 1. If any of the following conditions exist or questions arise concerning the serviceability of couplings, remove the assembly from service until the issues are resolved:
 - a. Excessive corrosion or pitting on the exterior and/or interior surfaces of the coupling.
 - b. Worn, broken, missing or damaged components.
 - c. Corrosion, excessive wear, damage or missing components on clamping devices.
 - d. Missing or improperly functioning safety devices.
- 2. For more detailed inspection information, refer to the following procedures:
 - Procedure 3000: Criteria for Sufficient Fit of a Boss™ Clamp (page 48)
 - Procedure 3001: Bolt Clamp Inspection (pages 49-50)
 - Procedure 3002: Band Clamp Inspection (page 52)
 - Procedure 3003: Inspecting Dixon® Cam and Groove (pages 53-54)

Hose

- 1. Inspect the entire length of the hose cover for blisters or soft spots. If either condition exists, discard the assembly. DO NOT pop the blisters. Blisters contain the product that was being conveyed through the hose. That material may be hazardous to personnel, equipment or the environment.
- 2. Inspect the entire length of the hose cover for cuts, gouges, abrasions or other imperfections like cracking, checking, dry rot, etc. If the hose cover is damaged to the point that the helical wire (if present) or the reinforcement is exposed, remove the assembly from service.
- 3. Inspect the entire length of the hose for 'kinked' or crushed spots.

Warning! These spots can cause a hose to burst, resulting in the destruction of property and/or serious injury or death to personnel.



If the spot has reduced the hose OD by 20% or more, remove the assembly from service. If the damage has reduced the OD by less than 20%, the assembly may be used if it passes hydrostatic testing. Refer to:
Procedure 4000: General Hydrostatic Testing Information (page 60),
Procedure 4001: Hydrostatic Test Procedure (page 61) and
Procedure 4002: Test Pressures for Boss-Lock™ and Dixon® Cam and Groove (page 62).
- 4. Inspect both ends of the hose tube for blisters, cracks, tears or separation. If any of these conditions exist, remove the assembly from service.
- 5. Remove any assembly from service if questions arise concerning the hose. Do not return the assembly to service until those issues have been resolved.

Procedure 3006: Inspection of EZLink™ Armless Cam and Groove Couplings

effective 06/16

Notes

- 1. These procedures provide guidelines for determining the serviceability of used EZLink™ Armless Cam and Groove couplings.
- 2. Distributors or end users must not alter Dixon® products. Alterations include but are not limited to changing the shape or number of nodes or serrations, buffing, grinding, filing, drilling, cutting or welding any surface. If any such modifications are discovered in the inspection process, the product must be made inoperable and discarded.
- 3. During the inspection process, protective eye wear and rubber gloves should be worn at all times.
- 4. Assemblies made of previously used EZLink™ cam and groove couplings must also be pressure tested. Test the assembly using:
 - Procedure 4000: General Hydrostatic Testing Information
 - Procedure 4001: Hydrostatic Test ProcedureConsult Dixon® engineering for test pressures. The distributor is responsible for maintaining test records.
- 5. Procedure 3101: Changing EZLink™ Tabs should be used as a reference.

Process

EZLink™ Armless Couplers (styles C and DC)

- 1. Examine the bellow seal area for nicks, gouges, scratches, dents, corrosion or pitting. If any of these conditions are present, discard the coupler.
- 2. Examine the tabs for dents or excessive wear. If either of these conditions is present on either tab, replace both tabs, springs and pins.
- 3. Check tabs for free movement in and out. If either tab does not move freely through its entire range of motion, replace both tabs, springs and pins.
- 4. Compare the old tabs to a new one to see if either are damaged or worn. If one or both are damaged or worn, replace both tabs, springs and pins.
- 5. Check the coupler for roundness by inserting a new adapter. If the adapter does not move freely in and out of the coupler before the tabs lock, discard the coupler.

EZLink™ Bellow Seal Inspection (if the tabs do not need replacing)

- 1. Take the seal out and check for any cracks, tears, nicks and make sure media is not trapped in the bellows area. If there is any damage to the seal, replace it with a new Dixon® bellow seal that is compatible with the material that is to be conveyed.
- 2. The seal is marked with directional arrows on the inside diameter to show which way it should be inserted into the coupler.
- 3. Warning! Only use EZLink™ seals for this coupling system. Traditional cam and groove gaskets or other types of seals are not compatible and will fail. 
- 4. Visit dixonvalve.com for seal material options and identification guidelines. If there is any question about which gasket to install, call Dixon® at 877-963-4966 for a recommendation.

Hose Shanks (style C)

- 1. Examine the nodes or serrations for any cuts, scratches, gouges or flat spots. If any of these conditions are present on any of the nodes or serrations, discard the coupling.
- 2. Examine the inside of the shank for pitting or corrosion. If either is present, discard the coupling.

Procedure 3100: Cam Arm Replacement for Boss-Lock™ Couplers

effective 06/16

Process for Pull-Ring Safety Clip and EZ Boss-Lock™ Handles

- 1. Inspect safety pin lug (see item 2 below) as follows:
 - a. For handles having the pull ring safety clip, a hole in the pin lug must be present. If the hole is closed or the lug is worn down to the hole, discard the coupler.
 - b. For EZ Boss-Lock™ handles, if the pin lug (see item 2 below) is bent, worn, broken or in any way altered, discard the coupler.
- 2. Place the coupler in a vise as follows:
 - a. Open the vise slightly wider than the coupler body width.
 - b. Position the coupler so that it is resting on the safety pin lugs (see item 2 below).
 - c. Position the coupler so the vise jaws will contact the coupler body (see item 1 below) just below the cam arm lugs (see item 3 below).
 - d. Making sure that the cam arms (see item 4 below) are in the full open position, snug the vise on the coupler body.



Caution! Do not tighten excessively. Excessive vise pressure can distort the coupler.

- 3. Using a standard round punch and hammer, tap the cam arm pin (see item 5 below) through the cam arm (see item 4 below) and through the opposite side cam arm lug (see item 3 below).
- 4. Holding on to the cam arm (see item 4 below), remove the punch from the cam arm lugs (see item 3 below) and lift out the cam arm.
Note: Once the cam arm pins and cam arms have been removed, discard them. Never install used cam arm pins or used cam arms.
- 5. Using a new cam arm pin, place either end into the cam arm lug hole (see item 3 below). Using a hammer, gently tap the cam arm pin until it begins to enter the opening between the two cam arm lugs.
- 6. Using a new cam arm, position it between the cam arm lugs and gently tap the cam arm pin with a hammer until it enters the hole in the cam arm. Continue tapping the cam arm pin until it is flush with the cam arm lug.
- 7. Repeat the above steps for the other cam arm.
Note: Always replace both cam arm pins and both cam arms even if only one cam arm is damaged.
- 8. Inspect as follows:
 - a. *For Pull Ring Safety Clip Handles:*
 - 1) Close the cam arm.
 - 2) Insert clip part of pull ring through the hole in the safety pin lug.
 - 3) Repeat above for the other cam arm.
 - 4) If both clips do not successfully engage the pin lug, remove cam arms and pins and discard the coupler.
 - b. *For EZ Boss-Lock™ handles:*
 - 1) Close the cam arm.
 - 2) Grasp the pull ring and attempt to pull the cam arm away from the coupler body
 - 3) Repeat above for the other cam arm. If either cam arm opens up, remove the cam arm and pins and discard the coupler.

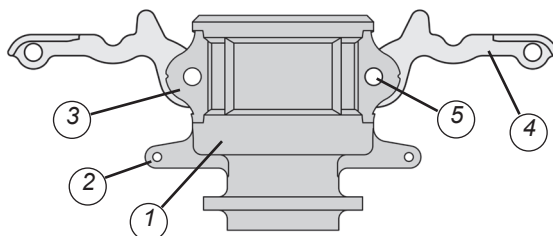

Procedure 3101: EZLink™ Tab Replacement for 2", 3" and 4" EZLink™ Cam and Groove Coupler

effective 06/16

Preparation

- 1. Inspect results using Procedure 3006: Criteria for Sufficient Fit of a Boss™ Clamp (page 57).
- 2. Replacement kit part numbers (1 kit required coupler):
 - a. EZL200RPLKIT - to be used on 2" couplers
 Contents: 2 pieces EZLT-200-SS (tabs)
 2 pieces EZLS-200-SS (springs)
 2 pieces 150-P (pins)
 - b. EZL300RPLKIT - to be used on 3" and 4" couplers
 Contents: 2 pieces EZLT-300-SS (tabs)
 2 pieces EZLS-300-SS (springs)
 2 pieces 325-P (pins)
- 3. When replacing tabs, always install a new bellow seal.

Process

- 1. Remove the safety pin.
- 2. Place the coupler in a vise as follows:
 - a. Open the vise slightly wider than coupler body width.
 - b. Position coupler so that the vise jaws will contact the coupler body just below the cam arms.

Caution! Do not tighten excessively. Excessive vise pressure can distort the coupler. 
- 3. Using a standard ¼" round punch and hammer, tap the pin from the non-grooved side through the tab and through the lugs.
- 4. Holding the tab, remove the punch from the lugs and lift out the tab and spring. *Note:* Once the tab, pin and spring have been removed, discard them. Never install tabs, pins or springs that have been previously used.
- 5. Holding the new tab with the part number visible, place the new spring into the slot.
- 6. Using your thumb and index finger, pinch the spring leg and tab so you can position it between the lugs, making sure the other leg of the spring is resting on the coupler.
- 7. Push the pin in until it enters the hole in the tab, through the spring and into the other lug.
- 8. Tap the pin using a hammer into the lug until it is flush with the outside of the lug.
- 9. Repeat the above steps for the other tab. *Note:* Always replace both tabs, pins and springs even if only one tab is damaged.
- 10. Make sure the tabs move freely without sticking.

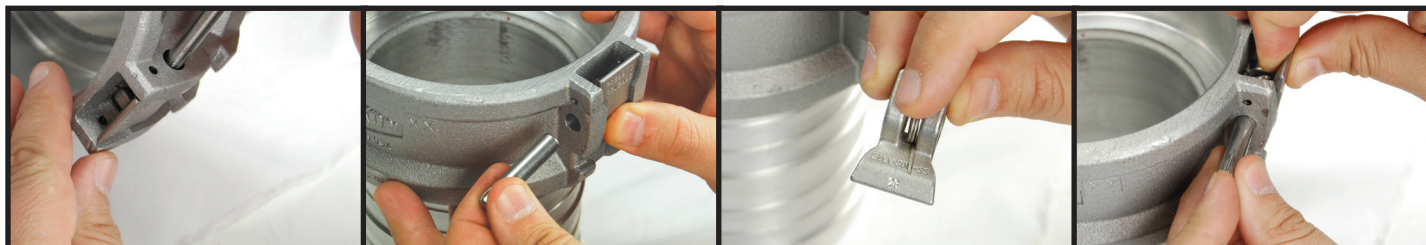

Process 3

Process 4

Process 5

Processes 6 and 7

Procedure 4000: General Hydrostatic Testing Information

effective 06/16

Caution! If the assembly requires both hydrostatic testing and electrical continuity testing, perform the electrical continuity test first. 

Required Information

- 1. Testing procedure:
 - a) Based on the type of hose, use the appropriate ARPM (Association for Rubber Products Manufacturers) Hose Technical Bulletin. Visit arpminc.com (formally regulated by Rubber Manufacturers Association) for the latest revision.
 - IP-11-1 Guide for Use, Maintenance, Testing and Inspection of Steam Hose
 - IP-11-2 Manual for Use, Maintenance, Testing and Inspection of Anhydrous Ammonia Hose
 - IP-11-4 Manual for Maintenance, Testing and Inspection of Oil Suction and Discharge Hose
 - IP-11-5 Guide for Use, Maintenance and Inspection of Welding Hose
 - IP-11-7 Manual for Maintenance, Testing and Inspection of Chemical Hose
 - IP-11-8 Manual for Maintenance, Testing and Inspection of Petroleum Service Station Gasoline Dispensing Hose and Hose Assemblies
 - b) If none of the above applies, consult the hose manufacturer.
- 2. Test pressure: Use the stated test pressure or the stated multiplier (i.e. 1.5, 2) for the assembly working pressure from the appropriate ARPM Test Procedure. Assembly working pressure is the *lesser* pressure rating of either the hose or the couplings.
- 3. The length of time the test pressure is to be held is stated in the ARPM Test Procedure.
- 4. If no hydrostatic test procedure or hose manufacturer hydrostatic testing information exists for the hose to be tested, test to 150% (1.5 times) the assembly working pressure and hold that pressure for 15 minutes.



WARNING! Before conducting any pressure tests on a hose, provisions must be made to ensure the safety of the personnel performing the tests and to prevent any possible damage to property. Only trained personnel using proper tools and procedures should conduct any pressure tests. 

For additional safety precautions, contact the hose manufacturer.

Procedure 4001: Hydrostatic Testing

effective 02/08

Process

- 1. Identify test requirements. Refer to Procedure 4000: General Hydrostatic Testing Information (page 60).
- 2. Lay the assembly in a straight line.
- 3. Install test caps or test plugs on both ends.
- 4. Connect a bleed-off valve to one end.
- 5. Connect test pump's intermediate hose (minimum 15 ft length) to the other end.
- 6. Position the pump at a 90° angle to the test sample and as far away as possible.
- 7. Elevate the end with the bleed-off valve and open the valve.
- 8. Fill the assembly with water.
- 9. Purge the air and close bleed-off valve.
Caution! Make certain all air is removed! 
- 10. Secure the ends to prevent damage in the event of an accidental coupling separation.
- 11. Activate the pump until the prescribed test pressure is achieved.
Warning! Do not allow anyone to stand near the ends of the assembly while it is under pressure. 
- 12. Hold test pressure for the prescribed length of time.
- 13. Check for leaks and/or coupling movement.
- 14. Turn off the test pump and the water supply.
- 15. Use the bleed-off valve (either on the test pump or connected to the test sample) to relieve pressure.
- 16. Remove test fixtures, drain water, and inspect assembly. Reference Procedure 3005: General Assembly Inspection (page 55).
- 17. If the assembly passed the hydrostatic test (did not leak and the coupling(s) did not move):
 - a. Complete the test report. Test reports can be supplied by the hose manufacturer, coupling manufacturer, or may be self-generated.
 - b. Tag or mark the assembly with all necessary information such as distributor name, date of assembly, test date, test pressure, assembly working, and primary assembly service (air, water, oil, etc).
 - c. Prepare the assembly for shipment.
- 18. If the assembly failed the hydrostatic test (leaked or the coupling(s) moved during the test):
 - a. Re-tighten or reinstall the couplings.
 - b. Retest the assembly.
 - c. Continue this process until the assembly does not leak and the couplings do not move. This may require installing different couplings that are better suited for the intended assembly working pressure.

Procedure 4002: Test Pressures for Boss-Lock™ and Dixon® Cam and Groove Couplings

effective 02/08

Note

- Working pressures and test pressures are subject to change. Consult Dixon® at 877-963-4966 for questions regarding working and test pressures.

Pressure Information

- 1. The working pressures and test pressures on the chart below are based upon hydrostatic testing at ambient temperature using standard gaskets. If media is other than water and/or temperature is other than ambient at 70°F (21°C), consult Dixon® for correct metal and elastomer recommendation.
- 2. The maximum test pressures given below are in no way to be used for a 'margin of error' or 'safety factor' in actual service working pressure. The actual service working pressure is never to exceed the stated maximum working pressures. The couplings and the hose are not designed to withstand elevated pressure for long durations. Maintaining working pressures higher than those stated for an extended period of time will result in hose and/or coupling damage or hose and/or coupling failure.
- 3. The maximum test pressures on the chart below should not be held longer than the prescribed duration as outlined in the ARPM (Association for Rubber Products Manufacturer's) Hose Handbook under Hydrostatic Test Procedures for that particular type of hose.
- 4. For chemical hose, the ARPM Test Procedure IP-11-7 (Manual for Maintenance, Testing, and Inspection of Chemical Hose) calls for new hose to be tested to 2x the working pressure. This is two times the lesser working pressure of the hose or the couplings (see working pressures below) held for the prescribed duration. This is the only instance where the 'test pressures' may be other than stated below.
- 5. When testing a hose assembly, all safety precautions should be taken to ensure that no harm or damage will occur to personnel or property in the event of a failure. Reference Procedure 4000: General Hydrostatic Testing Information (page 60) and Procedure 4001: Hydrostatic Testing (page 61).
- 6. Inspect the assembly. Reference Procedure 3005: General Assembly Inspection (page 56).

| Coupling Size | Commercial Working Pressure | Maximum Allowable Test Pressure |
|---------------|-----------------------------|---------------------------------|
| ½" | 150 PSI | 225 PSI |
| ¾" - 2" | 250 PSI | 375 PSI |
| 2½" | 150 PSI | 225 PSI |
| 3" | 125 PSI | 188 PSI |
| 4" | 100 PSI | 150 PSI |
| 5" and 6" | 75 PSI | 113 PSI |

Procedure 4100: Electrical Continuity Testing

effective 02/08

Note

- 1. An assembly that requires static grounding, like steam hose or chemical hose, must be tested for electrical continuity. The test ensures that the static electrical charge, which builds up during the transport of certain products, has a path to ground.
- 2. Without a ground path, the static charge can cause serious damage to the carcass of the hose, life-threatening injuries to handling personnel, and/or an explosion that could result in extensive destruction of property.

Process

- 1. Before conducting an electrical continuity test, contact the hose manufacturer for instructions on the proper method and criteria.
- 2. Use a multimeter to perform the test. A multimeter registers electrical resistance in ohms.
- 3. Compare the multimeter reading to the one provided by the hose manufacturer. If the multimeter does not register or the reading is not what the hose manufacturer specified, reinstall the couplings to ensure that the grounding wire is contacting the couplings.
- 4. Retest the assembly.
- 5. Record the results, and tag or mark the assembly.

Be Safe

Hose assemblies must be inspected prior to each use. Worn out fittings, attachment devices, hose and accessory items must be replaced. Retaining devices (safety devices) such as clips, cables or chains must be used. Clamps must be checked regularly to the specified torque found in the Dixon® literature. Under no circumstance should any coupling be disconnected while under pressure unless the coupling is specifically designed to do so. Disconnecting couplings under pressure could result in serious injury or death, and destruction to property and equipment.

For all hose assemblies in use:

- Beware** - Hose assemblies when used improperly or in the wrong application can be dangerous. The maximum working pressure shown on the hose is not an indication of the working pressure of the assembly. Based on the hose, fittings and attachment method used, all assemblies should be permanently marked with the designed working pressure and the intended media. The assembly working pressure should be permanently displayed. Hose assemblies must be used for the intended service only. Never alter manufactured product or substitute component parts.

- Eliminate** - hazardous conditions by inspecting, maintaining and testing hose assemblies. Dixon® recommends that all hose assemblies be tested in accordance with the hose manufacturer's specifications. The application determines the regularity of the re-testing schedule.

- Secure** - and inspect hoses, fittings, clamping devices and safety accessories before each use. Never take for granted that the couplings or attachment devices are properly installed.

- Always** - inspect and re-tighten the bolts of any bolt-style clamping device to the manufacturer's torque specifications.

- Fittings** - Hoses and clamping devices that are worn out or damaged must be removed from service.

- Educate** - your employees about the proper use, care and potential hazards of hose assemblies. Take advantage of Dixon®'s free Hose Assembly Safety Program and the follow up Training Seminar to aid you in setting up your own inspection program. Any questions on applications, use or assembly call 877-963-4966.

General Safety Information

Pressure Ratings

Pressure ratings for couplings, as stated in this catalog, are based upon ambient temperature (**70°F, 21°C**) applications with true hose ID (Internal Dimension), new Dixon® supplied couplings, new Dixon® supplied clamps, new quality hoses, and proper installation by a qualified assembler using Dixon® procedures and equipment. In addition, temperature can affect coupling retention. For temperatures other than ambient (**70°F**), contact the hose manufacturer or call Dixon® at 877-963-4966.

Product Selection

Many of the products in this catalog are used in hose assemblies in a variety of applications. The safety of any hose assembly rests on the proper selection, installation, testing and use of each product. The safe use of any product in this catalog is dependent upon the correct selection of the hose, fittings and method of attachment. To ensure such a proper selection, the user must inform the distributor of the application and pressure involved when ordering hose assemblies. The use of S.T.A.M.P.E.D. (**S**ize, **T**emperature, **A**pplication, **M**edia, **P**ressure, **E**nds, **D**ixon®) will help in the proper selection of hose assembly components (see next page). The selection of couplings and clamping devices is the responsibility of the purchaser or user, based upon the hose manufacturer's recommendations. If the purchaser or user is uncertain about the use or application of a product, Dixon® stands ready to provide information, including test results (if available), coupling and clamping recommendations and other data to help resolve those matters.

Installation

To achieve a safe and reliable assembly, proper installation procedures must be followed. Each component of the assembly has a part in determining these procedures. The purchaser or user must follow proper procedures. If the purchaser or user has any questions regarding installation, please contact Dixon®.

Testing

Dixon® recommends that all hose assemblies be tested in accordance with the hose manufacturer's recommendations.

Re-testing and inspection

Dixon® recommends inspection and re-testing of hose assemblies on a regular and consistent basis in accordance with the hose manufacturer's recommendations. The application determines the regularity of the inspection and re-testing schedule. Any worn-out fittings, damaged hoses or missing safety devices should be replaced immediately. Bolt-style clamps must be checked and re-tightened on a regular and consistent basis.

⚠ WARNING

Failure to use these procedures can result in serious injury or death, and destruction of property and equipment.

Hose and Hose Coupling Safety

*"The very properties that make compressed gases useful in almost every area of modern life can also make them dangerous when mishandled. Years of experience with compressed gases have led to practices and equipment which, if employed, result in complete safety."*¹

Dixon® hose couplings have been carefully engineered to meet specific requirements. If hoses or couplings are not used in correct applications or are incorrectly applied, accidents and downtime can result. It is up to the end user to inform the distributor of the application and pressures involved when ordering hose assemblies and it is up to the distributor to supply the right hose and coupling for that application. When in doubt, Dixon® is here to help you with a proper coupling recommendation.

Air Hose Couplings

This form of energy can be one of the most dangerous because it is used in so many applications and, when mishandled, can have more serious results than fluids. Air, as a gas, is compressible. Fluids press only against hose or vessel walls and lose little volume under pressure. When pressurized air releases suddenly, it does so with explosive force and can cause rapid hose whip, which can do serious physical harm to personnel or damage to nearby objects. This is why the selection of proper hoses and couplings for air lines is so important, along with their proper installation and maintenance. Never take for granted that a coupling is installed properly or a clamp fully tightened on an air hose. Check it regularly and use safety devices (see paragraph 4).

Steam and Gas

The same rules apply for steam and gas, but because these are inherently more hazardous materials, personnel tend to treat hoses and couplings on these lines with more respect and care. Checking clamp tightness is very important with steam hoses, where it is not unusual for clamps to loosen in service, in which case they *must be re-tightened!* Safety devices should also be used (see paragraph 4).

Fluid Hose Couplings

Nothing should be taken for granted - in particular, check clamps for tightness each time the lines are used - especially when petroleum products or other hazardous liquids are involved. Large diameter hoses, when suspended, can also be quite dangerous if dropped unexpectedly due to a coupling "pull-out," or sudden disconnection. A heavy fitting or clamp, plus the weight of the hose itself falling from any significant height, can cause injuries or damage. Be sure to use safety devices (see paragraph 4).

All Hose Assemblies

All hose assemblies should be treated with respect as potential hazards. Worn-out fittings should be replaced. Retaining devices such as clips, cables or chains should be used. Clamps should be checked regularly. Under no circumstances should any coupling be disconnected while under pressure, unless the coupling is specifically designed to do so. Disconnecting couplings under pressure could result in serious injury or death, and destruction of property and equipment.

¹ "Handbook of Compressed Gases" (3rd ed.). (1990). New York, NY: Chapman & Hall. doi:10.1007/978-1-4613-0673-3

Hose and Hose Coupling Safety

- Use Dixon® couplings, retention devices and accessory products **only** for their intended service.
- All recommendations of the hose manufacturer and the coupling manufacturer must be employed with regards to **S**ize, **T**emperature, **A**pplication, **M**edia, **P**ressure, **E**nds and **D**ixon® when selecting the components for a hose assembly.
- All finished hose assemblies should be tested in accordance with the ARPM (Association for Rubber Products Manufacturers) recommendations.
- All hose assemblies should be thoroughly inspected prior to each use to ensure they are undamaged and properly coupled.
- Use safety clips on couplings and King Cable™ on assemblies where required by the manufacturer, as well as by state and federal regulations. (OSHA regulations may be viewed in full on the OSHA website, osha.gov.)
- Under no circumstances should the assembly working pressure or working temperature exceed the working pressure or working temperature of the lowest-rated component (coupling, clamp, ferrule or hose).
- Call Dixon® (877-963-4966) for advice on couplings, retention devices and accessories for your application.
- All hose assemblies should be viewed as potential hazards. This document is designed to inform and educate anyone who manufactures, specifies, supplies, purchases, assembles, uses, maintains or tests any hose assembly or its component parts. The proper selection and maintenance of hoses, couplings, attachment devices and accessories is imperative.
- Call Dixon® (877-963-4966) for advice on proper selection, care, use and maintenance of hose couplings and accessory items.
- It is the end user's responsibility to identify to the distributor the application and any special conditions that the hose assembly must meet. It is the distributor's responsibility to supply the proper assembly for the intended application. Accidents and downtime may occur if hose assemblies are not properly selected for the specific application.
- The performance and safety of the assembly is affected by the quality of the individual components. The use of the acronym S.T.A.M.P.E.D. (**S**ize, **T**emperature, **A**pplication, **M**edia, **P**ressure, **E**nds, **D**ixon®) will help in the proper selection of the hose assembly components (see page 64).

If anyone is uncertain about the use or application of a product, Dixon® can provide test results, coupling and clamping recommendations and other data to help resolve those matters. Call 877-963-4966 with any questions.

Glossary

A

| | |
|--------------------------|--|
| ANSI | American National Standards Institute, Inc. |
| API | American Petroleum Institute |
| ASA | American Standards Association |
| ASME | American Society of Mechanical Engineers |
| ASTM | American Society for Testing and Materials |
| Adapter | The grooved portion of a cam and groove coupling. Also a fitting that converts from one type or size to another type or size. |
| Anodize | A process for aluminum, similar to zinc or chrome plating steel, in which an aluminum part is electrically charged then dipped in various chemicals to produce various colors and/or surface hardness. |
| Armored Hose | Hose with a protective covering, applied as a braid or helix, to protect the hose from physical abuse. |
| Assembly | A reference to a hose having couplings installed in one or both ends. |
| Assembly Pressure Rating | The pressure rating (in PSI) of the lowest rated component, whether it be the hose or couplings. |
| Attachment | The method or process for securing a coupling to a hose (i.e. banding, clamping, swaging, crimping). |
| Autoclave | A pressure vessel used for vulcanizing rubber products by means of steam under pressure. |

B

| | |
|------------------|--|
| BSPP | British Standard Pipe Parallel thread |
| BSPT | British Standard Pipe Taper thread |
| Blister | A raised area or separation between hose layers creating a void or air-filled space. Can be visible on either the hose cover or the hose tube. |
| Bolt Hole Circle | A circle on the flange face around which the center of the bolt holes are distributed. |
| Bowl | The exterior shell of an expansion ring type coupling. |
| Braid | A continuous sleeve of interwoven single or multiple strands of material. In hose construction, these strands are usually textile or metal. |
| Braid Angle | The angle at the intersection of a braid strand and a line parallel to the axis of a hose. |
| Buffing | Grinding or removing surface material to obtain dimensional conformance. |
| Burst | A rupture caused by internal pressure. |
| Burst Pressure | The pressure at which rupture occurs. |

C

| | |
|-----------------|---|
| Carcass | The fabric, cord and/or metal reinforcing section of a hose as distinguished from the hose tube or cover. |
| Chamfer | To cut an angle on the hose tube to aid in stem insertion and to prevent the hose end from flaring when a stem is inserted. |
| Checking | See Cracking. |
| Clamp | A metal fitting, band or wire used around the outside of a hose end to secure a coupling, fitting or nipple. |
| Cold Flow | Continued deformation or movement under stress. |
| Compression Set | The deformation which remains in rubber after it has been subjected to and released from stress such as a clamp. The longer the stress is maintained the more definitive the deformation. |
| Corrugated Hose | A hose with an exterior that is radially or helically grooved to enhance flexibility and/or reduce weight. |
| Coupling | A device at the end or ends of a length of hose that allows a connection to be made. |
| Cover | The outermost part of the hose. The main purpose for the hose cover is to protect the hose reinforcement from physical and environmental abuse. Covers can have materials (rubber compounds) that are blended to produce characteristics such as ozone resistance, abrasion resistance or oil resistance. |
| Cracking | A sharp break or fissure in the hose surface. Usually caused by stress, flexing and/or environmental conditions. |
| Cracking | A surface effect on hoses characterized by multi-directional minute cracks. |
| Crimp Diameter | The finished dimension to which a ferrule or sleeve is reduced. |
| Crimping | The act of forming the metal sleeve or ferrule of a hose fitting with a surrounding series of die segments to compress the hose within the fitting. The crimping process changes the shape of the entire circumference and length simultaneously. Often interchanged with the term "swaged." |
| CWP | Cold working pressure |

D

| | |
|--------------------|---|
| Date Code | Any combination of letters, numbers or symbols to identify time and/or location of manufacture. |
| Deflection | The effect of crimping producing a change in shape or size of the stem. |
| Design Factor | See Safety Factor. |
| Dovetail Extension | The "fingers" on the sides of a clamp that interlock to prevent straight line leaks. |
| Durometer | An instrument for measuring the hardness of rubber. |
| Durometer Hardness | A numerical value indicating the resistance to indentation or displacement of a probe. The higher the value, the harder the material. |

E

| | |
|--------------------------|---|
| Eccentric Wall | In hose or tubing, a wall of varying thickness. |
| Eccentricity | In hose, tubing or cylindrical articles, the condition resulting from the inside and outside diameters not having a common center. |
| Elastomer | Any of various elastic substances resembling rubber. |
| Expansion Ring | Typically refers to a type of fire hose coupling that is attached by expanding a sleeve (usually brass) outward to compress the hose against the wall of the bowl of the coupling. |
| External Swage (Swaging) | A ferrule is passed through a reducing die, usually split, to bring the ferrule OD down to a pre-determined size (for proper coupling retention) forcing the hose tube down into the stem serrations. |

F

| | |
|---------------|---|
| FDA | Food and Drug Administration |
| Ferrule | A collar placed over a hose end to attach the fitting to the hose. The ferrule may be crimped or swaged, forcing the hose against the shank of the coupling or the shank may be expanded, forcing the hose out against the ferrule or both. |
| Fitting | See Coupling. |
| Flex cracking | Surface condition directly related to repeated bending and straightening. |
| Fluid | A substance (as liquid or gas) tending to flow or conform to the outline of its container. |
| Free OD | Hose Outside Diameter before stem is inserted. |

G

| | |
|------------------|--|
| GPM | Gallons per minute |
| Gripping Finger | The part of the clamp that goes over and behind the stem collar to aid in clamp retention. |
| Grooved Fittings | Typically refers to grooved style couplings. |

H

| | |
|---------------|--|
| Hard Coat | An anodizing process in which the surface hardness of aluminum becomes similar to or greater than that of case hardened steel. |
| Helix | A wire or other reinforcement material spiraled around the cylindrical body of a hose. |
| Hold Test | Subjecting a hose to a specific hydrostatic pressure for a specific duration. |
| Hose | A flexible conduit consisting of a tube, reinforcement and usually an outer cover. |
| Hose Assembly | A length of hose with a coupling attached to one or both ends. |

I

| | |
|-------------------------|---|
| ID | Inside Diameter |
| IPT | Iron Pipe Thread. Also known as NPT – National Pipe Taper thread. |
| ISO | International Standardization Organization |
| Impact | To strike with a mallet or hammer. |
| Impulse | An application of force in a manner to produce sudden strain or motion such as pressure spikes. |
| Internal Expansion (IX) | <ol style="list-style-type: none"> 1. A plug (aka bullet) is pulled through a stem to increase the stem ID to the plug OD. 2. A finger expander increases the ID to a predetermined size or pressure setting. Either process creates a full flow effect. |
| Investment Cast | Also known as the "Lost Wax" process. A wax mold that is an exact replica of the part to be produced is dipped in ceramic slurry. When dry, the part is placed in an oven to harden the ceramic and melt out the wax. From there the metal is poured to produce the desired part. |

J

| | |
|------------|--|
| JIC | Joint Industrial Committee |
| JIC Thread | Typically refers to the threads on hydraulic fittings having 37° conical sealing surfaces. |

K

| | |
|---------|--|
| Kamlock | Another name for cam and groove couplings. |
| Kinking | A temporary or permanent distortion of the hose induced by bending beyond the minimum bend radius. |

L

| | |
|--------|---|
| LPG | Liquefied Petroleum Gas |
| Leaker | <ol style="list-style-type: none"> 1. A crack or hole in the tube which allows the media to escape; 2. A hose assembly which allows the media to escape at the couplings. |
| Liquid | A fluid (such as water) that has no independent shape but has a definite volume and only slightly compressible. |

M

| | |
|------------------------|--|
| MAWP | Maximum Allowable Working Pressure |
| MSHA | Mine Safety and Health Administration |
| Mean | In the middle or average. |
| Media | Material (any material) being transported through a hose. |
| Minimum Burst Pressure | The lowest pressure at which rupture occurs under prescribed conditions. |

N

| | |
|--------------|--|
| NH | Same as NST |
| NPS | Same as NPSM |
| NPSM | American Standard Straight Pipe Thread For Free Mechanical Joints |
| NST | Fire hose thread |
| Necking Down | A localized decrease in the cross-sectional area of a hose. Also known as "goose-necking." |
| Nipple | The section of the fitting that is inserted into the hose. Also known as the shank of a coupling. |
| Nominal | 1. A dimensional value assigned for the purpose of convenient designation. 2. Average measurement |

O

| | |
|--------------------|--|
| OD | Outside Diameter |
| OS and D | Oil suction and discharge |
| Operating Pressure | The pressure at which a system functions. Also known as working pressure. |
| Ozone Cracking | The surface cracks, checks or crazing caused by exposure to an environment containing ozone. |

P

| | |
|-------------------|---|
| PSI | Pounds per square inch |
| PSIG | Pounds per square inch gauge |
| Pig | An object forced, usually via air pressure, through the length of an assembly to clean out any residual product. |
| Permanent Fitting | The type of fitting which, after it is applied, cannot be removed for reuse. |
| Permanent Set | The amount by which an elastic material fails to return to its original form after deformation. |
| Phonograph Finish | A series of small grooves cut into the surface of a shank to aid in coupling retention of hoses having hard tubes such as cross-linked polyethylene (XLPE) or ultra high molecular weight (UHMW). Grooves resemble those on a phonograph record. |
| Pitch | The distance from one point on a helix to the corresponding point on the next turn of the helix, measured parallel to the axis. |
| Pock Marks | Uneven blister-like elevations, depressions or pimpled appearance. |
| Polymer | A macromolecular material formed by the chemical combination of monomers having the same or different chemical composition. |
| Popcorn | Common to steam hoses. Small eruptions within the tube rip or tear away material leaving cavities in the tube. |
| Powder Coat | A process in which electrically charged dry plastic powder paint is applied to a metal surface or part. The part is then baked in an oven resulting in a finished part that has a uniform and durable finish. The only way to remove a powder coat finish is by sand blasting or burning. |
| Pricker Mark | A perforation of the hose cover to allow pressure build-up between the sections of a hose to escape before these pressures can damage the hose. Most common in steam hoses. |

R

| | |
|------------------|---|
| Reinforcement | The center part of the hose that gives it strength. The hose working pressure is dependent upon the type (or types) of reinforcement and the amount used in the hose construction. Reinforcement types are as follows: <ul style="list-style-type: none"> • Wire Braid • Helical Wire • Textile Braid • Wire Spiral • Textile Spiral |
| Reusable Fitting | Type of fitting that is designed to be removed from a hose and re-coupled onto another hose. |

S

| | |
|-------------|---|
| SAE | Society of Automotive Engineers |
| SAE Threads | Similar to J.I.C. except for 45° conical sealing surfaces. |
| SCFM | Standard Cubic Feet per Minute. Typically refers to the amount of compressed air an air compressor can produce. |

S continued...

| | |
|---------------------------------|---|
| SMOD | Stem mean outside diameter. The average diameter between the crest of the stem serrations and the root of the stem serrations. |
| Safety Factor | A ratio used to establish the working pressure of a hose based upon the burst pressure. Also known as "design factor." Typical safety factors are as follows: <ol style="list-style-type: none"> 1. Water hose up to 150 PSI WP: 3 to 1 2. Hose for all other liquids, solid materials suspended in liquids or air and water hose over 150 PSI WP: 4 to 1 3. Hose for compressed air and other gases: 4 to 1 4. Hose for liquid media that immediately changes into gas under standard atmospheric conditions: 5 to 1 5. Steam hose: 10 to 1 |
| Screw-Together Reusable Fitting | A type of hose fitting in which the socket and nipple, along with the hose, are screwed together. |
| Serration | The part of the shank (stem) that grips the hose tube. |
| Serration Crest | The top of the serration. |
| Serration Root | The bottom of the serration. |
| Service Test | Test in which the product is used under actual service conditions. |
| Set | The amount of deformation remaining after the stress has been relieved. |
| Shank | The section of the fitting or coupling that is inserted into the hose. |
| Shear | To break or cut off. |
| Shelf Storage Life | The period of time prior to use during which a product retains its intended performance capability. |
| Shell | See ferrule |
| Sintered | Process in which powdered metal is formed in a mold under extreme pressure to form a finished part. |
| Skive | To remove or cut away part of the hose cover exposing the reinforcement to permit the attachment of a coupling directly over the reinforcement. |
| Smooth Bore Hose | A wire-reinforced hose in which the wire is not exposed on the inner surface of the tube. |
| Smooth Cover | A hose cover having an even and uninterrupted surface. |
| Socket | The external member or portion of a hose fitting of a screw – together reusable fitting. |
| Soft End | A hose end in which the reinforcement, usually wire, is omitted. |
| Spike | A rapid rise of internal pressure followed by a rapid decrease of internal pressure. |
| Spring back | The attempt of the metal sleeve or ferrule to return to its original diameter. |
| Surge | A rapid rise of internal pressure. |
| Swage | See "external swage." Often interchanged with the term crimp. |

T

| | |
|--------|---|
| Torque | The amount of force required to turn an object, usually measured in inch pounds (in. lbs.) or foot pounds (ft. lbs.). |
| Tube | The inner-most part of the hose intended to contain the media being transported. Usually, rubber compounds or plastics are blended to give the tube specific properties so that it is compatible with certain medias. |

U

| | |
|------|--|
| UHMW | Ultra High Molecular Weight. Thin tube liner made from extremely dense material having excellent chemical resistance properties. |
| UN | Unified National (Constant Pitch) thread |
| UNC | Unified National Coarse thread |
| UNF | Unified National Fine Thread |

V

| | |
|-----------|---|
| Viscosity | A material's resistance to flow under pressure. |
|-----------|---|

W

| | |
|------------------|---|
| WOG | Water, oil, gas. Pressure rating for valves handling these products. This does not include steam. |
| WP | Working Pressure |
| Working Pressure | The maximum pressure to which a hose assembly will be subjected, including pressure surges. |

X

| | |
|------|--|
| XLPE | Cross-Linked Polyethylene. Tube material that has good chemical resistance properties. |
|------|--|

Dixon®, founded in 1916, is a premier manufacturer and supplier of hose couplings, valves, dry-disconnects, swivels, and other fluid transfer and control products. The company's global reach includes a wide range of products for numerous industries including petroleum exploration, refining, transportation, chemical processing, food & beverage, steel, fire protection, construction, mining and manufacturing. Dixon®'s strategic objective is to create solutions that make products safer, leak-free, longer lasting, and always available.

dixonvalve.com • *Customer Service:* **877.963.4966**



The Right Connection®

Dixon® Valve

800 High Street, Chestertown, MD 21620

ph: 877.963.4966

fx: 800.283.4966

connect with us on

